

SINGER
22W57,W59,W156,W158

LIST OF PARTS



MACHINES

Nos. 22w57, 22w59,
22w156 and 22w158

INDEX

	PAGE
ACCESSORIES	32
BOBBIN WINDER	32
FEED DOGS	35
FOOT LIFTER	35
KNEE LIFTER	33
MACHINE NO. 22w57	7
" " 22w59	17
" " 22w156	28
" " 22w158	30
MISCELLANEOUS PARTS	40
NUMERICAL LIST OF PARTS	43
OBSOLETE PARTS	41
ROLLER PRESSERS	36
THREAD UNWINDER	34
THROAT PLATES	39

THE SINGER MANUFACTURING COMPANY

Instructions for Ordering

In ordering from this list, use **ONLY** the **PART** number in the **FIRST** column.

The number stamped on a Sewing Machine Part is the number of the Single Part only, except when the part includes Set Screws, Clamping Screws, Studs and Rollers Spun on, Small Wires riveted, or Parts soldered together, etc., which it is necessary to furnish in combination.

Every combination of parts sent out has its specific number which, although not stamped on Parts (except in above case), must be used when ordering the combination.

Each number always indicates the **SAME PART** in whatever list it appears, or for whatever Machine.

The letters after some of the numbers indicate the style of finish only, as follows:

- A. Hardened, Polished and Plated.
- B. Polished and Plated.
- C. Hardened only.
- D. Polished only.
- E. Soft, not polished.
- F. Hardened and Polished.
- H. Blued.
- J. Nickel Plated only
- R. Merlized.
- Y. Black Nickel Plated only.

These letters **MUST BE USED** when they appear in the list and **AFTER** the number, as in the list.

In this series

- 200001 to 201500 and 350001 to 351500 are Screw Numbers.
- 201501 to 201800 and 351501 to 351800 are Nut Numbers.
- 201801 to 202000 and 350801 to 352000 are Roller Numbers.
- 202001 to 350000 are Numbers of Machine Parts.

The figures in the second column refer only to the plate in which the illustration of the part is shown and are **NOT TO BE USED** in ordering.

Two or more numbers over a cut indicate that the difference between such parts is not visible in an illustration.

Parts marked with an asterisk (*) are furnished only when repairs are made at the factory.

LIST OF PARTS COMPLETE

FOR

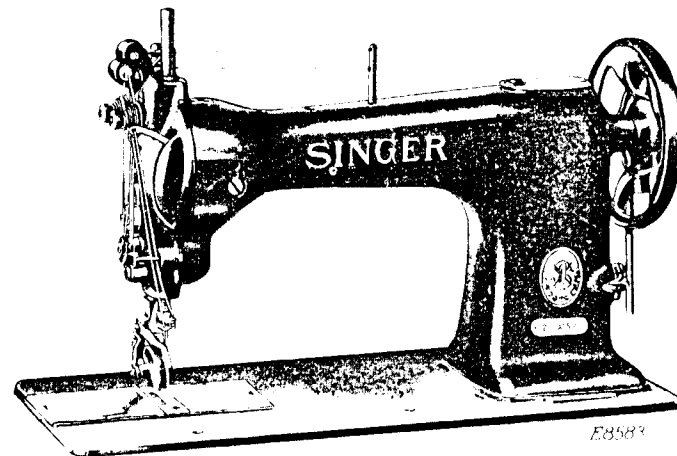

MACHINE No. 22w57

DROP FEED. ROLLER PRESSER

For Vamping, Foxing, Stitching Gloves, Etc.

In gauges from $\frac{3}{32}$ to $\frac{1}{16}$ inch

No.	Plate	Name
*204161	----	Arm with 200439c, 202036 and 204705
204163	12305	Arm Cap
200278H	12311	" " Screw
202248	12307	" " " Washer
204235	13045	" Position Pin (2)
200963E	12311	" Screw (3)
202005	12308	" " Washer (3)
203202	12333	" Shaft
204705	12334	" " Bushing (front)
200439c	12311	" " " Position Screw ..
204440	12333	" " Connection with four 200054e (2)
200054E	12307	Arm Shaft Connection Screw
202299	----	" " Oil Packing (wick) (2)
204805	12333	Balance Wheel, 5 $\frac{1}{2}$ in. diam. (belt groove 2 $\frac{3}{4}$ in. diam.), with 200328c and 200335c

Parts for Machine No. 22w57

No.	Plate	Name
200062n	12311	Balance Wheel Adjusting Screw ..
200328c	12311	" " Position Screw
200335c	12311	" " Set Screw
*203300	- - -	Bed with 203248, 203249, 203376, two each 200362c, 200516E, 200840E and 202299
202258	13105	Bed Hinge Connection (2)
200570E	12311	" " " Screw (4)
203329	11886	" Slide (back)
203301	12334	" " (front)
203470	11249	Bobbin
*203498	- - -	" Case
203648	12151	" " Latch
*202056	- - -	" " " Pin
203473	12151	" " " Plunger
203474	12151	" " " Spring
203499	11249	" " Lever
203476	- - -	" " " Eccentric
204243	13105	" " " " Position Pin
203506	11249	" " " Fulcrum
200056E	10884	" " " " Screw
203478	11249	" " " Slide Stud
203214	13045	" " Tension Spring
200984c	13045	" " " " Regulat- ing Screw
200594c	13045	Bobbin Case Tension Spring Screw
203216	- - -	" " Washer (cloth)
203500	11249	Bobbin Case complete, Nos. 200594c, 200984c, 202056, 203214, 203216, 203473, 203474, 203498 and 203648
204533	12333	Face Plate with 200366n, 204730, two each 200368n, 202090, 204281 and three 200397n
200053c	12311	Face Plate Screw
204730	13105	" " Thread Guide
200397n	12309	" " " " Set Screw
204534	- - -	Face Plate complete, Nos. 200113E, 200135E, 200319c, 200577n, 204277 to 204280, 204330, 204533, 204555, two each 200309E, 204059 and 204272
203303	12334	Feed Bar with 204189
Note: Use Feed Bar Loop Guard No. 203304 and two screws No. 200131E on machines when using Feed Dog without anvil or loop separator.		
203309	- - -	Feed Bar 203303 with 200214E, 201525E and 204200

INDEX

	PAGE
ACCESSORIES	32
BOBBIN WINDER	32
FEED DOGS	35
FOOT LIFTER	35
KNEE LIFTER	33
MACHINE No. 22w57	7
" " 22w59	17
" " 22w156	28
" " 22w158	30
MISCELLANEOUS PARTS	40
NUMERICAL LIST OF PARTS	43
OBSOLETE PARTS	41
ROLLER PRESSERS	36
THREAD UNWINDER	34
THROAT PLATES	39

LIST OF PARTS COMPLETE

FOR

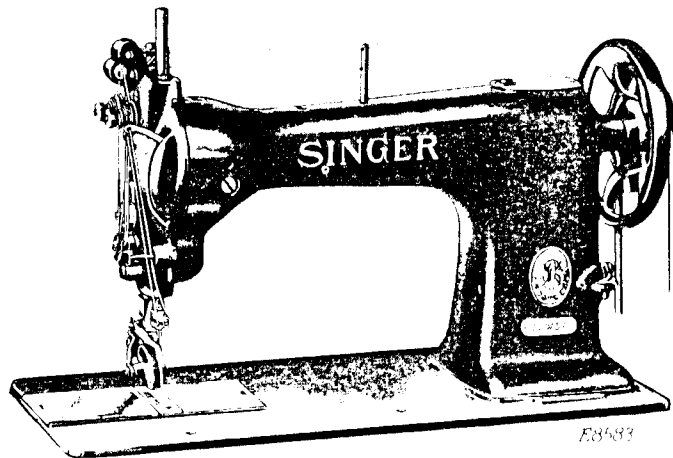

MACHINE No. 22w57

DROP FEED. ROLLER PRESSER

For Vamping, Foxing, Stitching Gloves, Etc.

In gauges from $\frac{1}{32}$ to $\frac{1}{16}$ inch

No.	Plate	Name
*204161	---	Arm with 200439c, 202036 and 204705
204163	12305	Arm Cap
200278H	12311	" " Screw
202248	12307	" " Washer
204235	13045	" Position Pin (2)
200963E	12311	" Screw (3)
202005	12308	" " Washer (3)
203202	12333	" Shaft
204705	12334	" " Bushing (front)
200439c	12311	" " Position Screw ..
204440	12333	" " Connection with four 200054E (2)
200054E	12307	Arm Shaft Connection Screw
202299	---	" " Oil Packing (wick) (2)
204805	12333	Balance Wheel, 5 $\frac{1}{4}$ in. diam. (belt groove 2 $\frac{3}{4}$ in. diam.), with 200328c and 200335c

Parts for Machine No. 22w57

No.	Plate	Name
200214E	13105	Feed Bar Hinge Screw
201525E	13105	" " " " Nut
214421	13105	" " Spring
204189	12306	" " Hook
212103	13106	" Dog, for 212178
200106E	12311	" " Screw (2)
200075E	13105	" " Support Screw
201535E	13105	" " " " Nut
203233	12305	" Driving Cam with 200382c and 200437c
204192	---	Feed Driving Cam Fork Lever with 204195 and 204293
204193	12334	Feed Driving Cam Fork Lever Connection with 200668c and 201525e
204194	12306	Feed Driving Cam Fork Lever Connection Clamp with 200031E
200031E	12311	Feed Driving Cam Fork Lever Connection Clamp Pinch Screw
200668c	13105	Feed Driving Cam Fork Lever Connection Clamp Screw Stud
201525E	13105	Feed Driving Cam Fork Lever Connection Clamp Screw Stud Nut..
200002E	12338	Feed Driving Cam Fork Lever Connection Hinge Screw
201522E	12338	Feed Driving Cam Fork Lever Connection Hinge Screw Nut
*204195	---	Feed Driving Cam Fork Lever Shaft
204197	12306	Feed Driving Cam Fork Lever Shaft Collar with 200113E
200113E	12308	Feed Driving Cam Fork Lever Shaft Collar Set Screw
204293	12308	Feed Driving Cam Fork Lever Shaft Position Pin
204196	12307	Feed Driving Cam Fork Lever Shaft Sleeve (split)
200043c	12311	Feed Driving Cam Fork Lever Shaft Sleeve Set Screw
201524E	12338	Feed Driving Cam Fork Lever Shaft Sleeve Set Screw Nut
204198	12334	Feed Driving Cam Fork Lever complete, Nos. 204192 and 204194 ...
200437E	12311	Feed Driving Cam Position Screw
200382c	13045	" " " " Set Screw
204199	12333	" " Rock Shaft
206551	---	" " " " 204199 with 200002E, 201522E and 204193

Parts for Machine No. 22w57

No.	Plate	Name
202305	12307	Feed Driving Rock Shaft Center (2)
200043c	12311	" " " " " Set Screw (2)
204200	12305	Feed Driving Rock Shaft Crank with 204189 (on left side) and two 200383c
200383c	12311	Feed Driving Rock Shaft Crank Set Screw
213007	12151	Feed Lifting Cam with 202126
204202	12308	" " " Fork with 200027E
200027E	12338	" " " Pinch Screw
202126	12308	" " " Position Pin
200045E	12338	" " " Screw
203305	12334	" " Rock Shaft
203315	12334	" " " " 203305 with 203238
202305	12307	Feed Lifting Rock Shaft Center (2)
200043c	12311	" " " " " Set Screw (2)
202276	12308	Feed Lifting Rock Shaft Slide Block
203238	12308	" " " " " " 202276 with 200243E and 201531E
200243E	12338	Feed Lifting Rock Shaft Slide Block Hinge Screw
201531E	12308	Feed Lifting Rock Shaft Slide Block Hinge Screw Nut
204206	12306	Feed Regulating Handle
204207	12334	" " " 204206 with 200098E, 202622, 204208 to 204210, 204213 and 204925
204208	12307	Feed Regulating Handle Adjustable Stop
200098E	12307	Feed Regulating Handle Adjustable Stop Screw
204925	12306	Feed Regulating Handle Adjustable Stop Screw Washer
204209	12307	Feed Regulating Handle Position Pin
204210	12306	Feed Regulating Handle Shaft
204211	12306	" " " " Crank with 200098E
204212	12307	Feed Regulating Handle Shaft Crank Link
200271E	12311	Feed Regulating Handle Shaft Crank Link Hinge Screw (lower)
200291E	12307	Feed Regulating Handle Shaft Crank Link Hinge Screw (upper)
200098E	12307	Feed Regulating Handle Shaft Crank Set Screw

Parts for Machine No. 22w57

No.	Plate	Name
204213	12307	Feed Regulating Handle Shaft Sleeve (split)
200362c	12311	Feed Regulating Handle Shaft Sleeve Set Screw
202622	12306	Feed Regulating Handle Shaft Sleeve Washer
202036	12338	Feed Regulating Handle Stop Pin
204214	---	Feed Regulating Handle complete, Nos. 200291E, 204207, 204211 and 204212
*203482	---	Hook (sewing)
203483	11249	" 203482 with 201253E, 201376E and 203251
203503	12151	Hook and Bobbin Case complete, Nos. 203483 and 203500
213810	11249	Hook Bevel Gear Socket, 24 teeth
200555H	11007	" " " " Screw ...
203242	11007	" " Pinion, 24 teeth, with two 200383c (2)
200383c	12311	Hook Bevel Pinion Set Screw
203306	12333	" Counter Shaft
203244	11007	" " " Collar with two 200393c
200393c	11007	Hook Counter Shaft Collar Set Screw
203245	11007	Hook Counter Shaft Driving Gear, 44 teeth, with 200362c and 200439c
213157	---	Hook Counter Shaft Driving Gear 203245 with 200045E and 213007
200439c	12311	Hook Counter Shaft Driving Gear Position Screw
200362c	12311	Hook Counter Shaft Driving Gear Set Screw
203246	11007	Hook Counter Shaft Gear, 22 teeth, with two 200383c
200383c	12311	Hook Counter Shaft Gear Set Screw
202299	---	" " " Oil Packing (wick)
200840E	11007	Hook Counter Shaft Oil Packing (wick) Stop Screw
203247	12333	Hook Driving Shaft
203248	12334	" " " Bearing with 202299
202299	---	Hook Driving Shaft Bearing Oil Packing (wick)
202126	12308	Hook Driving Shaft Bearing Posi- tion Pin

Parts for Machine No. 22w57

No.	Plate	Name
200516E	12311	Hook Driving Shaft Bearing Screw
203249	11007	" " Bushing (eccentric)
202299	-----	Hook Driving Shaft Bushing Oil Packing (wick)
200362C	12311	Hook Driving Shaft Bushing Set Screw
213141	13045	Hook Driving Shaft Collar with two 200393C
200393C	11007	Hook Driving Shaft Collar Set Screw
203251	12151	Hook Gib
201376E	13045	" " Hinge Screw
201253E	13045	" " Screw
203508	11249	" Saddle (left or right) with 200056E
200006E	11007	Hook Saddle Screw (4)
202622	12306	" " Washer (4) ...
213018	11249	" Washer with 203476 and two 204243
203509	11249	Hook Saddle (left or right) complete, Nos. 200555n, 203478, 203499, 203503, 203506, 203508, 213018 and 213810
203510	-----	Hook Saddle Combination (left and right) complete, Nos. two 203509
208490	12152	Knee Lifter Connection Lever
227311	-----	" " " " 208490 with 227302, 227308 and two 200262n
200262n	12306	Knee Lifter Connection Lever Hinge Screw
227308	12152	Knee Lifter Connection Lever Lifting Rod with 202302
202302	12306	Knee Lifter Connection Lever Lifting Rod Cotter Pin
227302	12152	Knee Lifter Lifting Lever
200262n	12306	" " " " Hinge Screw
231390	11886	Needle Bar (hollow)
204248	12307	" " Connecting Link
200658C	12307	" " " " Hinge Screw Stud
201519E	12307	Needle Bar Connecting Link Hinge Screw Stud Nut
204249	12308	Needle Bar Connecting Stud with 200072C and 202277
202277	-----	Needle Bar Connecting Stud Oil Packing (wick)

Parts for Machine No. 22w57

No.	Plate	Name
200072C	12308	Needle Bar Connecting Stud Pinch Screw
204326	12338	Needle Bar Packing Cord (2)
200504E	13105	" " Screw Bushing (lower)
200503E	13105	" " " " (upper)
231381	13106	" Holder, needles $\frac{3}{8}$ in. apart and must be set diagonally, in gauges $\frac{1}{8}$, $\frac{3}{16}$ and $\frac{1}{4}$ in., with 201030E and two 200141E
201030E	13105	Needle Holder Screw
200141E	12151	" Set Screw
204252	12308	Presser Bar Lifter
200550C	12311	" " " Hinge Screw ...
204253	12308	" " Lifting Bracket with 200086C
200086C	12308	Presser Bar Lifting Bracket Pinch Screw
204254	12307	Presser Bar Lifting Bracket Position Guide
200362C	12311	Presser Bar Lifting Bracket Position Guide Set Screw
204327	12306	Presser Bar Packing Washer (felt)
200504E	13105	" " Screw Bushing (lower)
204258	13045	" " Spring (heavy)
200491E	12305	" " Thumb Screw (pressure regulating)
201906	11748	Roller Presser, $1\frac{1}{2}$ in. diam., $\frac{3}{8}$ in. face (fine), with 200548C and 201534n
202839	---	Roller Presser Arm
204567	11748	" " " 202839 with 201906
229341	11748	Roller Presser Arm Bracket (swing)
229344	-----	Roller Presser Arm Bracket 229341 with 200096n, 201071E, 204567 and 229325
200675E	12151	Roller Presser Arm Bracket Position Screw Stud
202558	12151	Roller Presser Arm Bracket Spring
229370	-----	" " " " " " Stop and Back Needle Guard Holder
229371	11748	Roller Presser Arm Bracket Spring Stop and Back Needle Guard Holder 229370 with 200350n, 201317E and 226220

Parts for Machine No. 22w57

No.	Plate	Name
200350H	11748	Roller Presser Arm Bracket Spring Stop and Back Needle Guard Holder Adjusting Screw
200141F	12151	Roller Presser Arm Bracket Spring Stop and Back Needle Guard Holder Set Screw
200096D	12151	Roller Presser Arm Screw
204495	12160	" " Bar
200548c	13045	" " Hinge Screw
201534H	12151	" " " " Nut
229328	11748	" " Needle Guard (back), for gauges $\frac{3}{32}$, $\frac{1}{8}$ and $\frac{1}{4}$ inch ...
201317F	12151	Roller Presser Needle Guard (back) Clamp Screw
226220	11748	Roller Presser Needle Guard (back) Clamp Screw Washer ...
229325	11748	Roller Presser Needle Guard (front), in gauges $\frac{3}{32}$, $\frac{1}{8}$ and $\frac{1}{4}$ inch
201071F	11748	Roller Presser Needle Guard (front) Screw
229345	12160	Roller Presser and Bar complete, in gauges $\frac{3}{32}$, $\frac{1}{8}$ and $\frac{1}{4}$ in., Nos. 200675E, 202558, 204495, 229328, 229344, 229371 and two 200141F ..
213006	13045	Take-up Cam with 200335c, 200383c, 200430c, 200658c and 201519E ...
203172	12307	Take-up Cam Friction Washer
200430c	12311	" " Position Screw
200383c	12311	" " " " Check Screw
200335c	12311	Take-up Cam Set Screw
203311	12151	" Lever
221454	---	" " 203311 with 204263 ...
204263	12151	" " Bearing with 204264 ..
204264	12306	" " " Position Pin ...
200042F	12311	" " " Screw
201816	12307	" " Roller
203312	12151	Take-up Lever complete, Nos. 200042F, 201816 and 221454
244018	12309	Tension Disc
202090	12309	" " Position Pin
204555	12338	" Release Lever
200309E	12309	" " " Screw
202075	12309	" " Plunger
208489	12159	" " Slide
206698	12159	" " " Spring
202407	10881	" Spring
200632B	12309	" Stud

Parts for Machine No. 22w57

No.	Plate	Name
200397H	12309	Tension Stud Set Screw
201572B	10881	" Thumb Nut
204271	12309	" Washer
204272	12309	Tension complete, Nos. 200632B, 201572B, 202075, 202407, 204271 and two 244048
204273	12308	Thread Controller Adjusting Collar with 200684H (for Presser Bar) ..
200684H	12308	Thread Controller Adjusting Collar Screw
204274	12309	Thread Controller Plate
200577H	12311	" " " Screw
202098	12309	" " Roller
204275	12309	" " " Guard
202084	12309	" " " " Washer
200300c	12309	" " " Screw
204276	12309	" " Spring
204333	12309	" " " Guard
200581H	12309	" " " Screw
204277	12309	" " " Stop
204278	12309	" " " " Driving Gear
200319c	12309	Thread Controller Spring Stop Driv- ing Gear Hinge Screw
200135E	12309	Thread Controller Spring Stop Screw
204279	12309	Thread Controller Spring Stud with 204925
200366H	12309	Thread Controller Spring Stud Set Screw
204925	12306	Thread Controller Spring Stud Washer
205987	12309	Thread Controller complete, Nos. 200300c, 200581H, 202084, 202098, 204274, 204275 and 204333
204280	12309	Thread Controller and Spring com- plete, Nos. 204276 and 205987 ...
204556	13105	Thread Guide
203313	13105	" "
204329	---	" Oiler (felt)
204330	12159	" " Bracket with 204329 ...
200113F	12308	" " " Screw
204281	12309	" Retainer Guide Wire
202091	12309	" " Sleeve
202092	12309	" " Spring
204058	12309	" " Stud
200368H	12309	" " Set Screw

Parts for Machine No. 22w57

No.	Plate	Name
204059	12309	Thread Retainer complete, Nos. 202091, 202092 and 204058
212178	12154	Throat Plate, 53 elongated needle hole, needles $\frac{3}{16}$ in. apart, for needle sizes 14 and 15, in gauges $\frac{1}{16}$, $\frac{3}{16}$ and $\frac{1}{4}$ in. for 212103
200161d	12319	Throat Plate Clamp Screw
203376	12159	" " Position Pin
200577u	12311	" " Screw

LIST OF PARTS COMPLETE

FOR

MACHINE No. 22w59

DROP FEED. ROLLER PRESSER

For Vamping, Foxing, Space-stitching, Tipping,
Stitching Gloves, Etc.

In gauges from $\frac{1}{16}$ to $\frac{1}{4}$ inch

No.	Plate	Name
*204161	- - -	Arm with 200439c, 202036 and 204705
204163	12305	Arm Cap
200278u	12311	" " Screw
202248	12307	" " " Washer
204235	13045	" Position Pin (2)
200963e	12311	" Screw (3)
202005	12308	" " Washer (3)
203202	12333	" Shaft
204705	12334	" " Bushing (front)
200439c	12311	" " " Position Screw ..
204440	12333	" " Connection with four 200054e (2)
200054e	12307	Arm Shaft Connection Screw
202299	- - -	" " Oil Packing (wick) (2)
204805	12333	Balance Wheel, 5 $\frac{1}{2}$ in. diam. (belt groove 2 $\frac{3}{4}$ in. diam.), with 200328c and 200335c
200062u	12311	Balance Wheel Adjusting Screw ..
200328c	12311	" " Position Screw
200335c	12311	" " Set Screw
*203300	- - -	Bed with 203248, 203249, 203376, two each 200362c, 200516e, 200840e and 202299
202258	13105	Bed Hinge Connection (2)
200570e	12311	" " " Screw (4)
203329	11886	" Slide (back)
203301	12334	" " (front)
203470	11249	Bobbin (2)
*203498	- - -	" Case
203648	12151	" " Latch
*202056	- - -	" " " Pin
203473	12151	" " " Plunger
203474	12151	" " " Spring

Parts for Machine No. 22w59

No.	Plate	Name
203499	11249	Bobbin Case Lever
203476	-----	" " " Eccentric
204243	13105	" " " " Position Pin
203506	11249	Bobbin Case Lever Fulcrum
200056E	10884	" " " " Screw ..
203478	11249	" " " Slide Stud
203214	13045	" " Tension Spring
200984c	13045	" " " " Regulat- ing Screw
200594c	13045	Bobbin Case Tension Spring Screw
203216	-----	" " Washer (cloth)
203500	11249	Bobbin Case complete, Nos. 200594c, 200984c, 202056, 203214, 203216, 203473, 203474, 203498 and 203648
204533	12333	Face Plate with 200366u, 204739, two each 200368u, 202090, 204281 and three 200397u
200053c	12311	Face Plate Screw
204730	13105	" " Thread Guide
200397H	12309	" " " " Set Screw
204534	-----	Face Plate complete, Nos. 200113c, 200135e, 200319c, 200577u, 204277 to 204280, 204330, 204533, 204555, two each 200309e, 204059 and 204272
203303	12334	Feed Bar with 204189
		Note: Use Feed Bar Loop Guard No. 203304 and two screws No. 200131e on machines when using Feed Dog without anvil or loop separator.
203309	-----	Feed Bar 203303 with 200214c, 201525e and 204200
200214c	13105	Feed Bar Hinge Screw
201525E	13105	" " " " Nut
214424	13105	" " Spring
204189	12306	" " Hook
212117	12167	" Dog, for 212182
212120	12167	" " " 212183
212151	12167	" " " 212191
212148	12167	" " " 212192
212154	12167	" " " 212193
211805	12167	" " " 212194
200106E	12311	" " Screw (2)
200075E	13105	" " Support Screw
201535E	13105	" " " " Nut
203233	12305	" Driving Cam with 200382c and 200437c

Parts for Machine No. 22w59

No.	Plate	Name
204192	-----	Feed Driving Cam Fork Lever with 204195 and 204293
204193	12334	Feed Driving Cam Fork Lever Con- nection with 200668c and 201525e
204194	12306	Feed Driving Cam Fork Lever Con- nection Clamp with 200031f
200031f	12311	Feed Driving Cam Fork Lever Con- nection Clamp Pinch Screw
200668c	13105	Feed Driving Cam Fork Lever Con- nection Clamp Screw Stud
201525e	13105	Feed Driving Cam Fork Lever Con- nection Clamp Screw Stud Nut
200002e	12338	Feed Driving Cam Fork Lever Con- nection Hinge Screw
201522e	12338	Feed Driving Cam Fork Lever Con- nection Hinge Screw Nut
*204195	-----	Feed Driving Cam Fork Lever Shaft
204197	12306	Feed Driving Cam Fork Lever Shaft Collar with 200113f
200113f	12308	Feed Driving Cam Fork Lever Shaft Collar Set Screw
204293	12308	Feed Driving Cam Fork Lever Shaft Position Pin
204196	12307	Feed Driving Cam Fork Lever Shaft Sleeve (split)
200043c	12311	Feed Driving Cam Fork Lever Shaft Sleeve Set Screw
201524e	12338	Feed Driving Cam Fork Lever Shaft Sleeve Set Screw Nut
204198	12334	Feed Driving Cam Fork Lever com- plete, Nos. 204192 and 204194 ...
200437c	12311	Feed Driving Cam Position Screw
200382c	13045	" " " Set Screw
204199	12333	" " Rock Shaft
206554	-----	" " " " 204199 with 200002e, 201522e and 204193
202305	12307	Feed Driving Rock Shaft Center (2)
200043c	12311	" " " " " Set Screw (2)
204200	12305	Feed Driving Rock Shaft Crank with 204189 (on left side) and two 200383c
200383c	12311	Feed Driving Rock Shaft Crank Set Screw
213007	12151	Feed Lifting Cam with 202126
204202	12308	" " " Fork with 200027e
200027e	12338	" " " " Pinch Screw

Parts for Machine No. 22w59

No.	Plate	Name
202126	12308	Feed Lifting Cam Position Pin
200045E	12338	" " " Screw
203305	12334	" " Rock Shaft
203315	12334	" " " " 203305 with 203238
202305	12307	Feed Lifting Rock Shaft Center (2)
200043C	12311	" " " " " Set Screw (2)
202276	12308	Feed Lifting Rock Shaft Slide Block
203238	12308	Feed Lifting Rock Shaft Slide Block 202276 with 200243E and 201531E
200243E	12338	Feed Lifting Rock Shaft Slide Block Hinge Screw
201531E	12308	Feed Lifting Rock Shaft Slide Block Hinge Screw Nut
204206	12306	Feed Regulating Handle
204207	12334	" " " 204206 with 200098F, 202622, 204208 to 204210, 204213 and 204925
204208	12307	Feed Regulating Handle Adjust- able Stop
200098F	12307	Feed Regulating Handle Adjust- able Stop Screw
204925	12306	Feed Regulating Handle Adjust- able Stop Screw Washer
204209	12307	Feed Regulating Handle Position Pin
204210	12306	Feed Regulating Handle Shaft
204211	12306	" " " " Crank with 200098F
204212	12307	Feed Regulating Handle Shaft Crank Link
200271E	12311	Feed Regulating Handle Shaft Crank Link Hinge Screw (lower)
200291E	12307	Feed Regulating Handle Shaft Crank Link Hinge Screw (upper)
200098F	12307	Feed Regulating Handle Shaft Crank Set Screw
204213	12307	Feed Regulating Handle Shaft Sleeve (split)
200362C	12311	Feed Regulating Handle Shaft Sleeve Set Screw
202622	12306	Feed Regulating Handle Shaft Sleeve Washer
202036	12338	Feed Regulating Handle Stop Pin

Parts for Machine No. 22w59

No.	Plate	Name
204214	----	Feed Regulating Handle complete, Nos. 200291E, 204207, 204211 and 204212
*203482	----	Hook (sewing)
203483	11249	" 203482 with 201253E, 201376F and 203251
203503	12151	Hook and Bobbin Case complete, Nos. 203483 and 203500
213810	11249	Hook Bevel Gear Socket, 24 teeth
200555H	11007	" " " " Screw ...
203242	11007	" " Pinion, 24 teeth, with two 200383C (2)
200383C	12311	Hook Bevel Pinion Set Screw
203306	12333	" Counter Shaft
203244	11007	" " " Collar with two 200393C
200393C	11007	Hook Counter Shaft Collar Set Screw
203245	11007	Hook Counter Shaft Driving Gear, 41 teeth, with 200362C and 200439C
213157	----	Hook Counter Shaft Driving Gear 203245 with 200045B and 213097..
200439C	12311	Hook Counter Shaft Driving Gear Position Screw
200362C	12311	Hook Counter Shaft Driving Gear Set Screw
203246	11007	Hook Counter Shaft Gear, 22 teeth, with two 200383C
200383C	12311	Hook Counter Shaft Gear Set Screw
202299	----	Hook Counter Shaft Oil Packing (wick)
200810E	11007	Hook Counter Shaft Oil Packing (wick) Stop Screw
203247	12333	Hook Driving Shaft
203248	12334	" " " Bearing with 202299
202299	----	Hook Driving Shaft Bearing Oil Packing (wick)
202126	12308	Hook Driving Shaft Bearing Posi- tion Pin
200516E	12311	Hook Driving Shaft Bearing Screw
203249	11007	" " " Bushing (eccen- tric)
202299	----	Hook Driving Shaft Bushing Oil Packing (wick)
200362C	12311	Hook Driving Shaft Bushing Set Screw

Parts for Machine No. 22w59

No.	Plate	Name
200064b	12167	Roller Presser Arm Screw, for $\frac{1}{4}$ in. gauge
229744	12167	Roller Presser Arm Shim, $\frac{1}{16}$ in. thick
229745	12167	Roller Presser Arm Shim, $\frac{1}{8}$ in. thick
202760	12167	Roller Presser Arm Shim, $\frac{1}{8}$ in. thick
204495	12160	Roller Presser Bar
200548c	13045	" " Hinge Screw
201534f	12151	" " " " Nut
229330	14309	" " Needle Guard (back), in $\frac{3}{8}$ in. gauge
229331	14309	Roller Presser Needle Guard (back), in $\frac{1}{4}$ in. gauge
229332	14309	Roller Presser Needle Guard (back), in $\frac{5}{8}$ in. gauge
229347	12167	Roller Presser Needle Guard (back), in $\frac{3}{8}$ in. gauge, with 350061f ..
229334	14309	Roller Presser Needle Guard (back), in $\frac{3}{8}$ in. gauge, with 350061f ..
229335	14309	Roller Presser Needle Guard (back), in $\frac{1}{4}$ in. gauge, with 350061f ..
201317f	12151	Roller Presser Needle Guard (back) Clamp Screw
226220	11748	Roller Presser Needle Guard (back) Clamp Screw Washer
350061f	12167	Roller Presser Needle Guard (back) Screw
229346	-	Roller Presser and Bar complete, in $\frac{3}{8}$ in. gauge, Nos. 200082b, 200675f, 202558, 204495, 204567, 229330, 229341, 229371, 229744, 229745 and two 200141f
229950	-	Roller Presser and Bar complete, in $\frac{1}{4}$ in. gauge, Nos. 200082b, 200675f, 202558, 202760, 204495, 204567, 229331, 229341, 229371 and two 200141f
229951	-	Roller Presser and Bar complete, in $\frac{5}{8}$ in. gauge, Nos. 200077b, 200675f, 202558, 202760, 204495, 204567, 229332, 229341, 229371, 229744 and two 200141f
229952	-	Roller Presser and Bar complete, in $\frac{3}{8}$ in. gauge, Nos. 200077b, 200675f, 202558, 202760, 204495, 204567, 229341, 229347, 229371, 229745 and two 200141f

Parts for Machine No. 22w59

No.	Plate	Name
229953	-	Roller Presser and Bar complete, in $\frac{3}{8}$ in. gauge, Nos. 200077b, 200675f, 202558, 202760, 204495, 204567, 229334, 229341, 229371, 229744, 229745 and two 200141f ..
229954	-	Roller Presser and Bar complete, in $\frac{1}{4}$ in. gauge, Nos. 200064b, 200675f, 202558, 204495, 204567, 229335, 229341, 229371, two each 200141f and 202760
213006	13045	Take up Cam with 200335c, 200383c, 200430c, 200658c and 201549f ..
203172	12307	Take up Cam Friction Washer
200430c	12311	" " Position Screw
200383c	12311	" " " " Check Screw
200335c	12311	Take up Cam Set Screw
203311	12151	" Lever
221454	-	" " 203311 with 204263 ..
204263	12151	" " Bearing with 204264 ..
204264	12306	" " " Position Pin
200042f	12311	" " " Screw
201816	12307	" " Roller
203312	12151	Take-up Lever complete, Nos. 200042f, 201816 and 221454
244048	12309	Tension Disc
202090	12309	" " Position Pin
204555	12338	" Release Lever
200309e	12309	" " " Screw
202075	12309	" " Plunger
208489	12159	" " Slide
206608	12159	" " " Spring
202407	10881	" Spring
200632b	12309	" Stud
200397h	12309	" " Set Screw
201572b	10881	" Thumb Nut
204271	12309	" Washer
204272	12309	Tension complete, Nos. 200632b, 201572b, 202075, 202407, 204271 and two 244048
204273	12308	Thread Controller Adjusting Collar with 200684h (for Presser Bar) ..
200684h	12308	Thread Controller Adjusting Collar Screw
204274	12309	Thread Controller Plate
200577h	12311	" " " Screw
202098	12309	" " Roller
204275	12309	" " " Guard
202084	12309	" " " Washer

Parts for Machine No. 22w59

No.	Plate	Name
200300c	12309	Thread Controller Roller Screw
204276	12309	" " Spring
204333	12309	" " " Guard
200581u	12309	" " " " Screw
204277	12309	" " " Stop
204278	12309	" " " " Driving Gear
200319c	12309	Thread Controller Spring Stop Driving Gear Hinge Screw
200135e	12309	Thread Controller Spring Stop Screw
204279	12309	Thread Controller Spring Stud with 204925
200366u	12309	Thread Controller Spring Stud Set Screw
204925	13105	Thread Controller Spring Stud Washer
205987	12309	Thread Controller complete, Nos. 200300c, 200581u, 202084, 202098, 204274, 204275 and 204333
204280	12309	Thread Controller and Spring complete, Nos. 204276 and 205987
204556	13105	Thread Guide
203313	13105	" "
204329	----	" Oiler (felt)
204330	12159	" " Bracket with 204329
200113f	12308	" " " Screw
204281	12309	" Retainer Guide Wire
202091	12309	" " Sleeve
202092	12309	" " Spring
204058	12309	" " Stud
200368u	12309	" " " Set Screw
204059	12309	Thread Retainer complete, Nos. 202091, 202092 and 204058
212182	12154	Throat Plate, 50 needle hole, for needle sizes 14 and 15, in $\frac{3}{8}$ in. gauge, for 212117
212183	12155	Throat Plate, 50 needle hole, for needle sizes 14 and 15, in $\frac{1}{2}$ in. gauge, for 212120
212191	12157	Throat Plate, 50 needle hole, for needle sizes 14 and 15, in $\frac{5}{8}$ in. gauge, for 212151
212192	12157	Throat Plate, 50 needle hole, for needle sizes 14 and 15, in $\frac{3}{4}$ in. gauge, for 212148

Parts for Machine No. 22w59

No.	Plate	Name
212193	12157	Throat Plate, 50 needle hole, for needle sizes 14 and 15, in $\frac{3}{8}$ in. gauge, for 212154
212194	12157	Throat Plate, 50 needle hole, for needle sizes 14 and 15, in $\frac{1}{2}$ in. gauge, for 211805
200161d	12319	Throat Plate Clamp Screw
203376	12159	" " Position Pin
200577u	12311	" " Screw

MACHINE No. 22w156

DROP FEED. ROLLER PRESSER

For Vamping, Foxing, Stitching Gloves, Etc.

In gauges from $\frac{3}{32}$ to $\frac{1}{16}$ inch

The same as Machine No. 22w57 with the following exceptions:

No.	Plate	Name
*204290	----	Arm with 200439c, 202036 and 204705, in place of 204161
213622	12333	Arm Shaft, in place of 202302
*213052	----	Bed with 203248, 203249, 203376, two each 200362c, 200516e, 200840r and 202299, in place of 203300
204294	12333	Feed Driving Rock Shaft, in place of 204199
206555	----	Feed Driving Rock Shaft 204294 with 200002r, 201522e and 204193, in place of 206554
202781	12152	Foot Lifter Lifting Lever
227306	“ “ “ “ 202781 with 200262n
227319	Foot Lifter Lifting Lever 227306 with 227318, in place of 227311 ..
200262n	12306	Foot Lifter Lifting Lever Hinge Screw
227308	12152	Foot Lifter Lifting Lever Rod with 202302
227318	Foot Lifter Lifting Lever Rod 227308 with 206628, 227227 and 227576
204126	Foot Lifter Lifting Lever Rod Clamp with two 200530c
227316	12388	Foot Lifter Lifting Lever Rod Clamp Hook
227576	12388	Foot Lifter Lifting Lever Rod Clamp Hook 227316 with 204126 ..
200530c	13105	Foot Lifter Lifting Lever Rod Clamp Set Screw
202302	12306	Foot Lifter Lifting Lever Rod Cotter Pin
206628	12388	Foot Lifter Lifting Lever Rod Spring

Parts for Machine No. 22w156

No.	Plate	Name
227227	12388	Foot Lifter Lifting Lever Rod Spring Collar with 200113f
200113f	12152	Foot Lifter Lifting Lever Rod Spring Collar Set Screw
213624	12333	Hook Driving Shaft, in place of 203247

MACHINE No. 22w158

DROP FEED. ROLLER PRESSER

For Vamping, Foxing, Space-stitching, Tipping,
Stitching Gloves, Etc.

In gauges from $\frac{3}{8}$ to $\frac{1}{4}$ inch

The same as Machine No. 22w59 with the following exceptions:

No.	Plate	Name
*204290	---	Arm with 200439c, 202036 and 204705, in place of 204161
213622	12353	Arm Shaft, in place of 202302
*213052	---	Bed with 203248, 203249, 203376, two each 200362e, 200516e, 200840e and 202299, in place of 203300 ..
204294	12333	Feed Driving Rock Shaft, in place of 204199
206555	---	Feed Driving Rock Shaft 204294 with 200002e, 201522e and 204193, in place of 206554
202781	12152	Foot Lifter Lifting Lever
227306	---	" " " " " 202781 with 200262n
227319	-----	Foot Lifter Lifting Lever 227306 with 227318, in place of 227311 ..
200262n	12306	Foot Lifter Lifting Lever Hinge Screw
227308	12152	Foot Lifter Lifting Lever Rod with 202302
227318	-----	Foot Lifter Lifting Lever Rod 207308 with 206628, 227227 and 227576
204126	---	Foot Lifter Lifting Lever Rod Clamp with two 200530c
227316	12388	Foot Lifter Lifting Lever Rod Clamp Hook
227576	12388	Foot Lifter Lifting Lever Rod Clamp Hook 227316 with 204126
200530c	13105	Foot Lifter Lifting Lever Rod Clamp Set Screw
202302	12306	Foot Lifter Lifting Lever Rod Cotter Pin
206628	12388	Foot Lifter Lifting Lever Rod Spring

Parts for Machine No. 22w158

No.	Plate	Name
227227	12388	Foot Lifter Lifting Lever Rod Spring Collar with 200113e
200113e	12308	Foot Lifter Lifting Lever Rod Spring Collar Set Screw
213624	12333	Hook Driving Shaft, in place of 203247

ACCESSORIES

FOR MACHINES NOS. 22w57 AND 22w59

No.	Plate	Name
200157b	12338	Attachment Screw
203470	11249	Bobbin (10)
*225482	- - -	" Case Screw Driver Blade ...
*225483	- - -	" " " " Handle ...
225497	11156	Bobbin Case Screw Driver complete, Nos. 225482 and 225483 ...
225487	11748	Roller Presser Hinge Screw Nut Wrench
128 x4	-----	Needles, four each, sizes 11, 12 and 13
228213	- - -	Drip Pan with four 1 in. wire nails
41400	12160	Machine Rest Pin (wood)
120342	11156	Oiler (copper plated) with 120343...
120343	11156	" Spout, 3½ in. long
*225484	- - -	Screw Driver Blade
*225485	- - -	" " Handle
225498	11156	Screw Driver complete (7¼ in. long), Nos. 225484 and 225485 ...
225554	11156	Wrench (steel)

BOBBIN WINDER

Swing Automatic, Right Hand

225453	10884	Bobbin Winder Frame with 202277 and 225438
225454	10884	Bobbin Winder Frame Hinge Pin
202277	- - -	" " " Oil Packing (wick)
225438	10884	Bobbin Winder Frame Oil Well Cap
225455	10884	" " " Spring
225456	10884	" " " " Plunger
202473	10885	" " Pulley with 200380c
200380c	12159	" " " Set Screw ...
225381	10884	" " Spindle
225444	10884	" " Stop Latch
200056e	10884	" " " " Screw ...
225458	10884	" " " " Thumb Lever
225459	10884	Bobbin Winder Stop Latch Thumb Lever Hinge Stud

Accessories

No.	Plate	Name
225459	10884	Bobbin Winder Stop Latch Thumb Lever Joint Stud
202478	10884	Bobbin Winder Stop Latch Trip Lever
200299n	10884	Bobbin Winder Stop Latch Trip Lever Hinge Screw
225461	10881	Bobbin Winder Tension Bracket with 201499b
200082b	10881	Bobbin Winder Tension Bracket Screw
228026	10884	Bobbin Winder Tension Bracket Screw Washer
2102	10881	Bobbin Winder Tension Disc
202407	10881	" " " Spring
201499b	10881	" " " Stud
201572b	10881	" " " " Thumb Nut
225462	10881	Bobbin Winder Tension Bracket complete, Nos. 201572b, 202407, 225461 and two 2102
225433	10885	Bobbin Winder and Tension Bracket Base
225382	10885	Universal Bobbin Winder complete, Nos. 200056e, 200082b, 200299n, 202473, 202478, 225381, 225433, 225444, 225453 to 225456, 225458, 225462, 228026, two each 225459 and wood screws ¾ in., No. 12, R.H.B.

KNEE LIFTER

2763	13395	Rock Shaft
228278	13395	" " Hanger (back) with 356c
228279	-----	Rock Shaft Hanger 228278 with 202452 and 228282
228280	13395	Rock Shaft Hanger (front) with two 356c
228281	- - -	Rock Shaft Hanger 228280 with 202452 and 228282
228282	13395	Rock Shaft Hanger Bracket with two wood screws ¾ in., No. 12 ..
202452	12319	Rock Shaft Hanger Hinge Pin
202455	13395	" " Knee Arm
356c	12159	" " " " Set Screw...
228284	13395	" " " Plate with 356c...
356c	12159	" " " " Set Screw...

Accessories

No.	Plate	Name
228283	13395	Rock Shaft Lifting Lever with two 356c
227728	13395	Rock Shaft Lifting Lever Rod with 227729
227729	---	Rock Shaft Lifting Lever Rod Cap
356c	12159	" " " " " Set Screw
356c	12159	Rock Shaft Lifting Lever Set Screw
356c	12159	" " Set Screw
228285	13395	Knee Lifter Rock Shaft complete, Nos. 2763, 202455, 227728, 228279, 228281, 228283 and 228284

(Other Knee Lifter parts are listed with parts of machine head.)

THREAD UNWINDER

225323	14083	Spool Rest (for one spool) with 201018c
225325	14083	Spool Rest (for two spools) with 201018c
225388	14083	Spool Rest Rod
200383c	12311	" " " Set Screw
201018c	12159	" " Set Screw
202490	14083	" Stand with 200383c
225391	14083	Thread Guide
201696j	12159	" " Lock Nut
225324	14083	" " Rod with 208E and 225322
208E	12159	Thread Guide Rod Screw
225322	12159	" " " Washer
225326	12159	" " Position Cup
225397	14083	Thread Unwinder (for three spools) complete, Nos. 201696j, 202490, 225323 to 225326, 225388, three each 225391 and wood screws 3/4 in., No. 12

Accessories

FOR MACHINES NOS. 22w156 AND 22w158

Same as for No. 22w57 with the following exceptions:

FOOT LIFTER

No.	Plate	Name
227952	11156	Foot Lifter Lever (left or right) with 227954
227678	11156	Foot Lifter Lever Chain, 48 in. long, with 202784
227954		Foot Lifter Lever Chain Hook (lower)
202784	12388	Foot Lifter Lever Chain Hook (upper)
225016	12388	Foot Lifter Lever Hinge Pin
227953	11156	" " " Stand with two wood screws 1 in., No. 12
227955	11156	Foot Lifter Lever (left or right) complete, Nos. 225016, 227678, 227952 and 227953, in place of 228285

FEED DOGS

212100	13106	Feed Dog, for 212176 to 212179
212103	13106	" " " 212176 to 212179
212104	13106	" " " 212176 to 212179
211650	13106	" " " 212180 and 212200
212151	12167	" " " 212173 and 212191
212117	12167	" " " 212182
212120	12167	" " " 212183
212123	12167	" " " 212184
212126	12167	" " " 212185
212129	12167	" " " 212186
212132	12167	" " " 212187
212175	12156	" " " 212188
211652	12167	" " " 212189 and 212202
212148	12167	" " " 212192
212154	12167	" " " 212193
211805	12167	" " " 212194

ROLLER PRESSERS

No.	Plate	Name
201906	11748	Roller Presser, $1\frac{1}{4}$ in. diam., $\frac{3}{8}$ in. face (fine), with 200548c and 201534u
201907	13106	Roller Presser, $1\frac{1}{4}$ in. diam., $\frac{3}{8}$ in. face (fine), with 200548c and 201534u
201908	11748	Roller Presser, $1\frac{1}{4}$ in. diam., $\frac{1}{2}$ in. face (fine), with 200548c and 201534u
201909	11748	Roller Presser, $\frac{11}{16}$ in. diam., $\frac{3}{8}$ in. face (coarse), with 200551c and 201534u
201910	12151	Roller Presser, $\frac{11}{16}$ in. diam., $\frac{1}{2}$ in. face (coarse), with 200551c and 201534u
201911	11748	Roller Presser, 1 in. diam., $\frac{1}{2}$ in. face (coarse), with 200551c and 201534u
202839	- - -	Roller Presser Arm
208497	12151	" " " "
204567	11748	" " " " 202839 with 201906
208498	12151	Roller Presser Arm 208497 with 201910
229341	11748	Roller Presser Arm Bracket (swing)
229344	-----	" " " " 229341 with 200096d, 201071f, 204507 and 229325
200675f	12151	Roller Presser Arm Bracket Position Screw Stud
202558	12151	Roller Presser Arm Bracket Spring
229370	-----	" " " " " " Stop and Back Needle Guard Holder
229371	11748	Roller Presser Arm Bracket Spring Stop and Back Needle Guard Holder 229370 with 200350u, 201317f and 226220
200350u	11748	Roller Presser Arm Bracket Spring Stop and Back Needle Guard Holder Adjusting Screw
200441f	12151	Roller Presser Arm Bracket Spring Stop and Back Needle Guard Holder Set Screw

Roller Pressers

No.	Plate	Name
200096d	12151	Roller Presser Arm Screw, for gauges $\frac{3}{8}$ to $\frac{1}{2}$ inch
200082d	10881	Roller Presser Arm Screw, for gauges $\frac{3}{8}$ and $\frac{1}{2}$ inch
200077d	12167	Roller Presser Arm Screw, for gauges $\frac{3}{8}$ to $\frac{3}{4}$ inch
200064d	12167	Roller Presser Arm Screw, for $\frac{1}{4}$ in. gauge
229744	12167	Roller Presser Arm Shim, $\frac{1}{16}$ in. thick
229745	12167	Roller Presser Arm Shim, $\frac{1}{8}$ in. thick
202760	12167	Roller Presser Arm Shim, $\frac{1}{4}$ in. thick
204495	12160	Roller Presser Bar
200548c	13045	" " Hinge Screw
200551c	12151	" " " "
201534u	12151	" " " " Nut
229328	11748	" " Needle Guard (back), for gauges $\frac{3}{8}$, $\frac{1}{2}$ and $\frac{3}{4}$ inch
229329	13106	Roller Presser Needle Guard (back), for $\frac{1}{8}$ in. gauge
229330	14309	Roller Presser Needle Guard (back), in $\frac{3}{8}$ in. gauge
229331	14309	Roller Presser Needle Guard (back), in $\frac{1}{2}$ in. gauge
229332	14309	Roller Presser Needle Guard (back), in $\frac{3}{4}$ in. gauge
229347	12167	Roller Presser Needle Guard (back), in $\frac{3}{8}$ in. gauge, with 350061f ..
229334	14309	Roller Presser Needle Guard (back), in $\frac{1}{2}$ in. gauge, with 350061f ..
229335	14309	Roller Presser Needle Guard (back), in $\frac{3}{4}$ in. gauge, with 350061f ..
229338	14309	Roller Presser Needle Guard (back), in gauges $\frac{3}{8}$, $\frac{1}{2}$ and $\frac{3}{4}$ in., with 200175u and 229339
215918	14309	Roller Presser Needle Guard (back), in gauges $\frac{3}{8}$, $\frac{1}{2}$ and $\frac{3}{4}$ in., with 200175u, 213699 and 350061f
201317f	12151	Roller Presser Needle Guard (back) Clamp Screw
226220	11748	Roller Presser Needle Guard (back) Clamp Screw Washer
350061f	12167	Roller Presser Needle Guard (back) Screw
213699	13106	Roller Presser Needle Guard (back) Spring Guide

Roller Pressers

No.	Plate	Name
229339	13106	Roller Presser Needle Guard (back) Spring Guide
200175H	12308	Roller Presser Needle Guard (back) Spring Guide Screw
229325	11748	Roller Presser Needle Guard (front), in gauges $\frac{1}{16}$, $\frac{3}{16}$ and $\frac{1}{2}$ inch
201071F	11748	Roller Presser Needle Guard (front) Screw
229345	13107	Roller Presser and Bar complete, in gauges $\frac{1}{16}$, $\frac{3}{16}$ and $\frac{1}{2}$ in., Nos. 200675F, 202558, 204495, 229328, 229344, 229371 and two 200141F
229346		Roller Presser and Bar complete, in $\frac{1}{8}$ in. gauge, Nos. 200082D, 200675F, 202558, 204495, 204567, 229330, 229341, 229371, 229744, 229745 and two 200141F
229950		Roller Presser and Bar complete, in $\frac{1}{4}$ in. gauge, Nos. 200082D, 200675F, 202558, 202760, 204495, 204567, 229331, 229341, 229371 and two 200141F
229951	-----	Roller Presser and Bar complete, in $\frac{5}{16}$ in. gauge, Nos. 200077D, 200675F, 202558, 202760, 204495, 204567, 229332, 229341, 229371, 229744 and two 200141F
229952		Roller Presser and Bar complete, in $\frac{3}{8}$ in. gauge, Nos. 200077D, 200675F, 202558, 202760, 204495, 204567, 229341, 229347, 229371, 229745 and two 200141F
229953	-----	Roller Presser and Bar complete, in $\frac{7}{16}$ in. gauge, Nos. 200077D, 200675F, 202558, 202760, 204495, 204567, 229334, 229341, 229371, 229744, 229745 and two 200141F
229954	---	Roller Presser and Bar complete, in $\frac{1}{2}$ in. gauge, Nos. 200064D, 200675F, 202558, 204495, 204567, 229335, 229341, 229371, two each 200141F and 202760

THROAT PLATES

FOR MACHINES NOS. 22w57 AND 22w156

No.	Plate	Name
212176	12154	Throat Plate, 53 needle hole, needles $\frac{1}{16}$ in. apart, for needle sizes 12 and 13, in gauges $\frac{1}{16}$, $\frac{3}{16}$ and $\frac{1}{2}$ in., for 212100, 212103 and 212104
212177	12154	Throat Plate, 50 needle hole, needles $\frac{1}{16}$ in. apart, for needle sizes 14 and 15, in gauges $\frac{1}{16}$, $\frac{3}{16}$ and $\frac{1}{2}$ in., for 212100, 212103 and 212104
212178	12154	Throat Plate, 53 elongated needle hole, needles $\frac{1}{16}$ in. apart, for needle sizes 14 and 15, in gauges $\frac{1}{16}$, $\frac{3}{16}$ and $\frac{1}{2}$ in., for 212100, 212103 and 212104
212179	12154	Throat Plate, 50 elongated needle hole, needles $\frac{1}{16}$ in. apart, for needle sizes 16 and 18, in gauges $\frac{1}{16}$, $\frac{3}{16}$ and $\frac{1}{2}$ in., for 212100, 212103 and 212104
212180	12154	Throat Plate, 50 needle hole, needles $\frac{1}{16}$ in. apart, for needle sizes 14 and 15, in gauges $\frac{1}{16}$, $\frac{3}{16}$ and $\frac{1}{2}$ in., for 211650
212200	12154	Throat Plate, 53 needle hole, needles $\frac{1}{16}$ in. apart, for needle sizes 12 and 13, in gauges $\frac{1}{16}$, $\frac{3}{16}$ and $\frac{1}{2}$ in., for 211650

FOR MACHINES NOS. 22w59 AND 22w158

212173	12157	Throat Plate, 53 needle hole, for needle sizes 12 and 13, in $\frac{1}{4}$ in. gauge, for 212151
212182	12154	Throat Plate, 50 needle hole, for needle sizes 14 and 15, in $\frac{1}{8}$ in. gauge, for 212117
212183	12155	Throat Plate, 50 needle hole, for needle sizes 14 and 15, in $\frac{1}{4}$ in. gauge, for 212120
212184	12155	Throat Plate, 50 needle hole, for needle sizes 14 and 15, in $\frac{1}{8}$ in. gauge, for 212123

Throat Plates

No.	Plate	Name
212185	12155	Throat Plate, 50 needle hole, for needle sizes 14 and 15, in $\frac{5}{16}$ in. gauge, for 212126
212186	12155	Throat Plate, 50 needle hole, for needle sizes 14 and 15, in $\frac{5}{16}$ in. gauge, for 212129
212187	12155	Throat Plate, 50 needle hole, for needle sizes 14 and 15, in $\frac{1}{4}$ in. gauge, for 212132
212188	12156	Throat Plate, 50 needle hole, for needle sizes 14 and 15, in gauges $\frac{5}{16}$ and $\frac{3}{8}$ in., for 212175
212189	12156	Throat Plate, 50 needle hole, for needle sizes 14 and 15, in gauges $\frac{5}{16}$ and $\frac{1}{4}$ in., for 211652
212191	12157	Throat Plate, 50 needle hole, for needle sizes 14 and 15, in $\frac{5}{16}$ in. gauge, for 212151
212192	12157	Throat Plate, 50 needle hole, for needle sizes 14 and 15, in $\frac{3}{8}$ in. gauge, for 212148
212193	12157	Throat Plate, 50 needle hole, for needle sizes 14 and 15, in $\frac{5}{16}$ in. gauge, for 212154
212194	12157	Throat Plate, 50 needle hole, for needle sizes 14 and 15, in $\frac{1}{4}$ in. gauge, for 211805
212202	12156	Throat Plate, 46 needle hole, for needle sizes 16 and 18, in $\frac{1}{4}$ in. gauge, for 211652

MISCELLANEOUS PARTS

Used in conjunction with Thread Unwinder

27739	12160	Thread Cone (wood)
60913	14083	Spool Weight with 60914
60914	-----	Center Pin
225377	14083	Wire, for small spools

OBSOLETE PARTS

No.	Plate	Name
202470	12320	Bobbin Winder Base
202471	12320	“ “ Frame
202472	12319	“ “ “ Spring
202474	12320	“ “ Spindle
227522	12319	“ “ Stop Latch
202477	12319	“ “ “ “ Thumb Lever
227523	12320	Bobbin Winder complete, Nos. 200056e, 200161b, 200221b, 201537b, 202470 to 202474, 202477, 202478, 227522, three 200299b and two round head wood screws $\frac{7}{8}$ in., No. 12
202480	12320	Bobbin Winder Spool Holder Base with 200355b and 202484
202481	12320	Bobbin Winder Spool Holder Base Spool Pin
202482	12319	Bobbin Winder Spool Holder Tension Disc (lower or upper)
202483	12319	Bobbin Winder Spool Holder Tension Disc Spring (brass)
202484	12319	Bobbin Winder Spool Holder Tension Disc Thread Guide
202485	12320	Bobbin Winder Spool Holder complete, Nos. 200011b, 202480, 202481, 202483, two 202482 and one wood screw 1 in., No. 13b ..
*213605	-----	Feed Driving Cam Fork Lever Slide Block
*213604	-----	Feed Driving Cam Fork Lever Slide Block with 200116e
213606	13104	Feed Driving Cam Fork Lever Slide Block 213604 with 213605 ..
202250	11007	Hook Driving Shaft Collar with two 200393e
204870	12333	Needle Bar (hollow)
203701	13106	“ Holder, needles $\frac{5}{16}$ in. apart and must be set diagonally, in gauges $\frac{5}{16}$, $\frac{3}{8}$, $\frac{7}{8}$ and $\frac{1}{2}$ in., with 200068b and two 200141e

PLATE 10881—FULL SIZE

225461

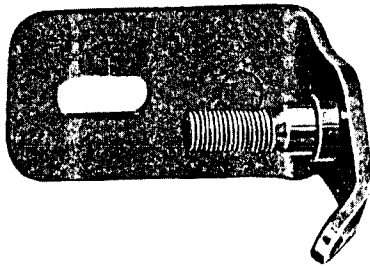

200082



202104



2102

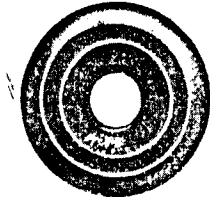

225462

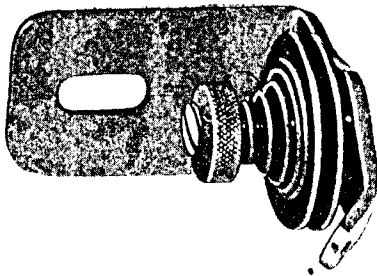

202407



201499



201572



PLATE 10884—FULL SIZE

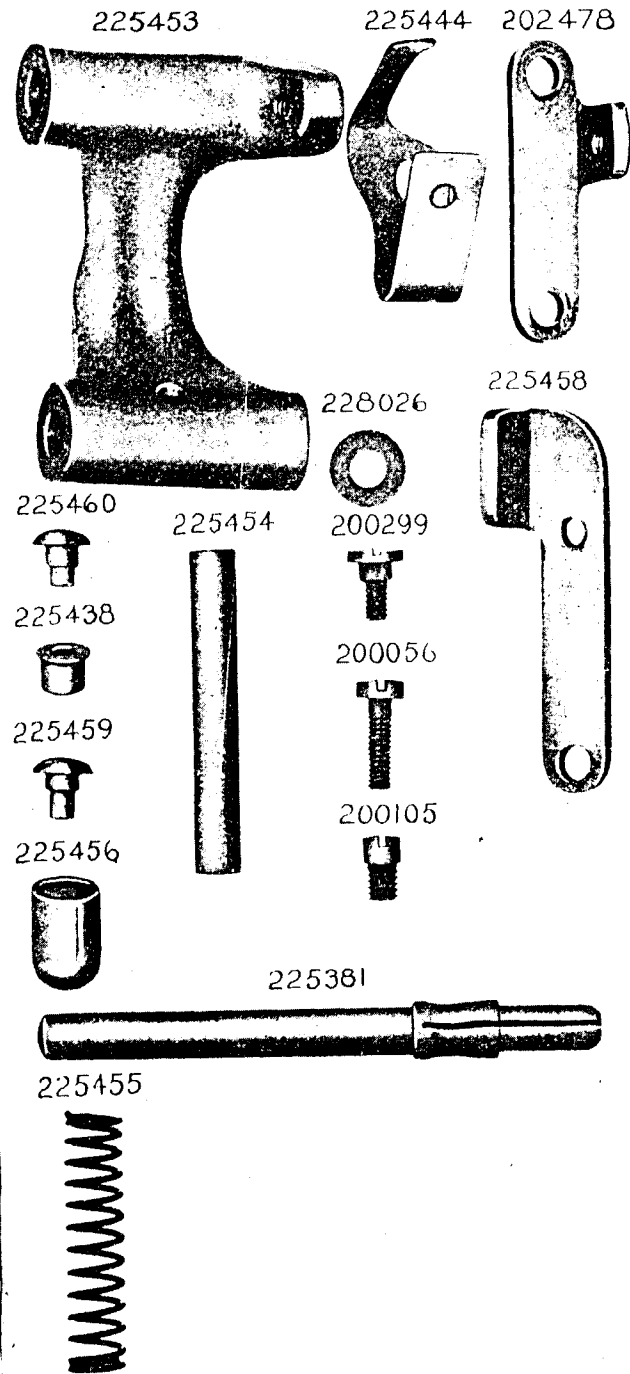

PLATE 10885—ONE-FOURTH SIZE

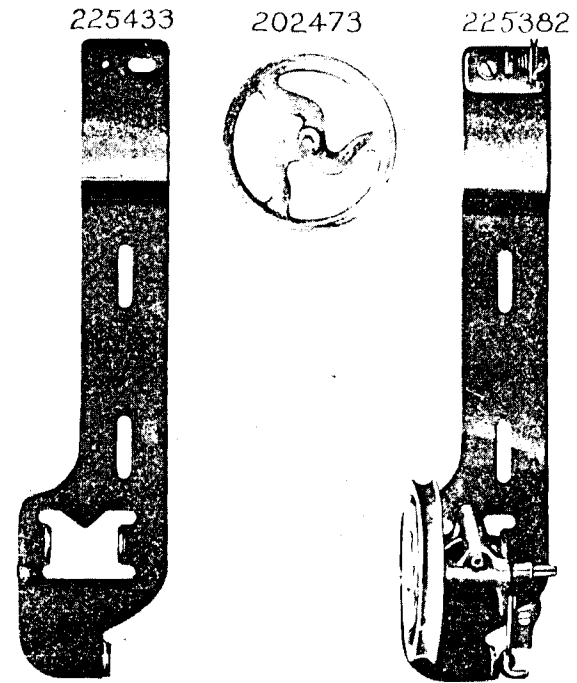

PLATE 11007—FULL SIZE

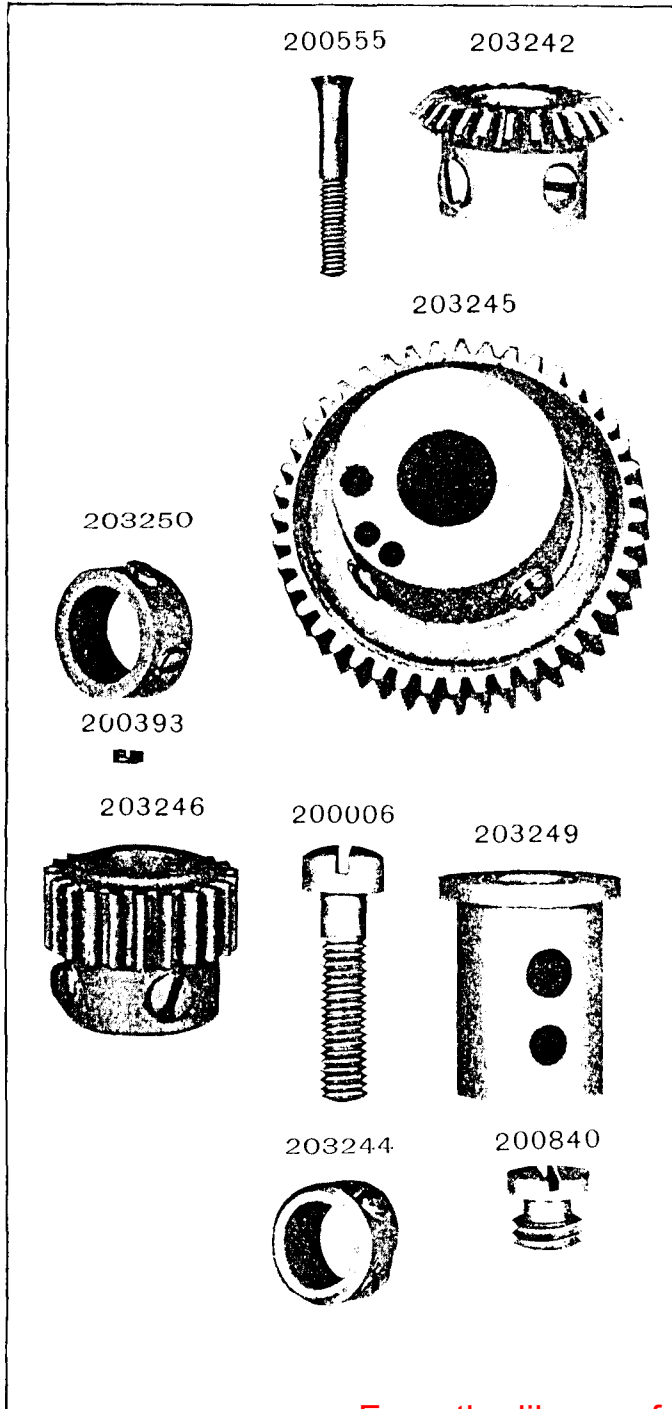

PLATE 11156 - ONE-FOURTH SIZE

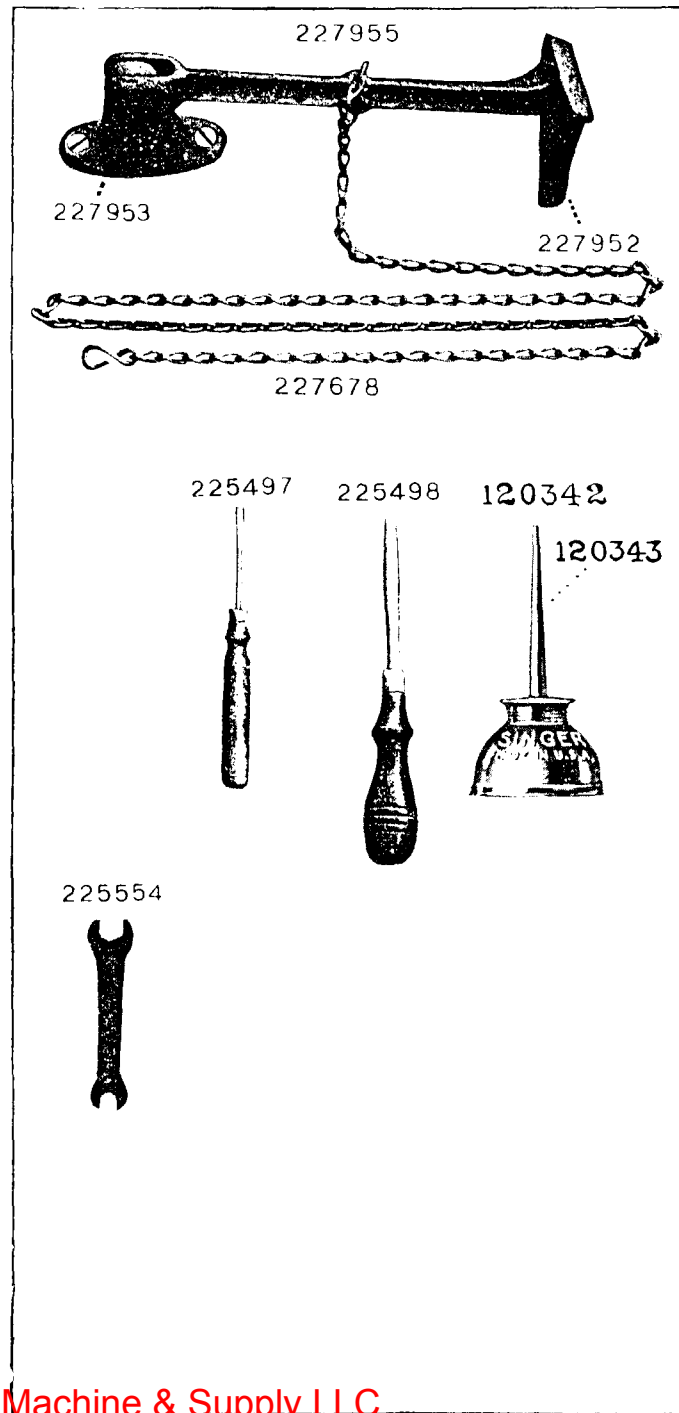

PLATE 11249—ONE HALF SIZE

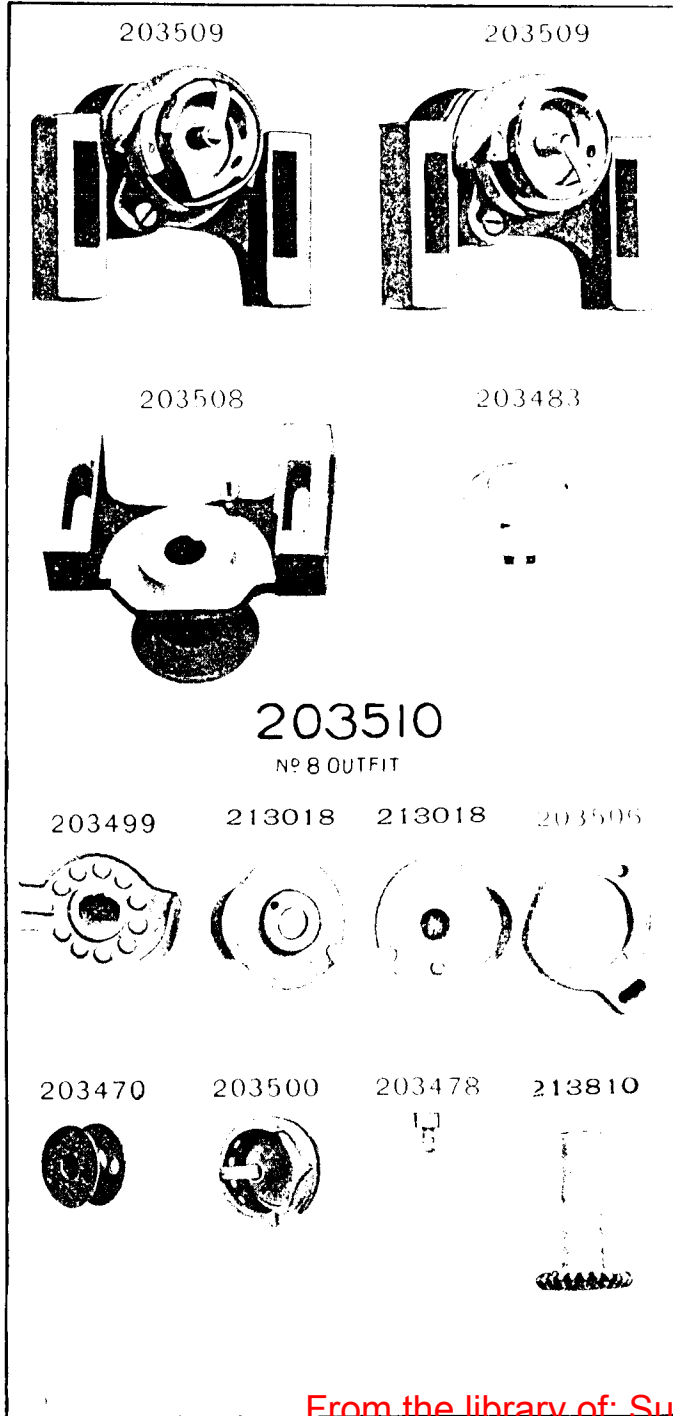

PLATE 11748—FULL SIZE

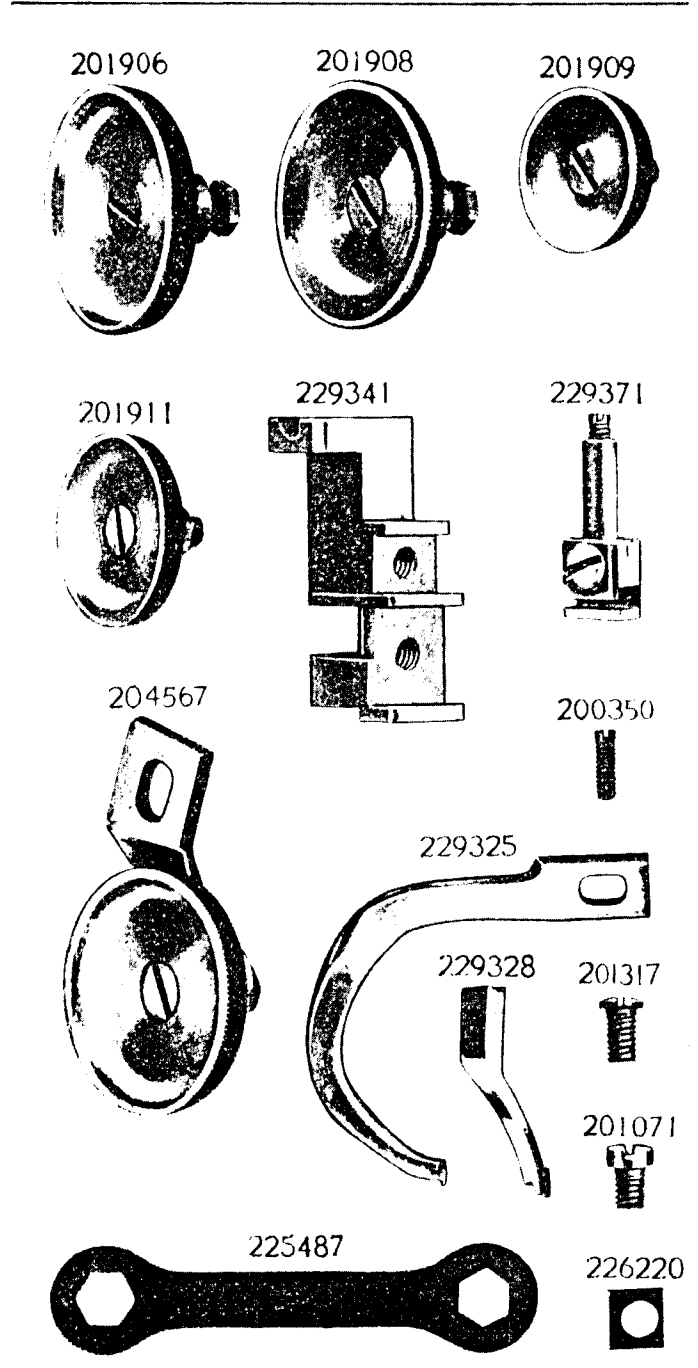

PLATE 11886—ONE-HALF SIZE

231390



203329

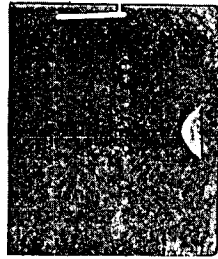
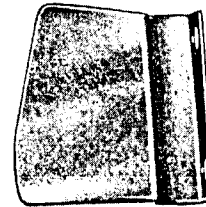

PLATE 12151—FULL SIZE

203304



203648



213007

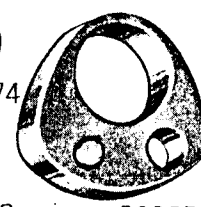

203473 203474



203503

203251

200131



200141



200675



202558



203311

200096



201534



201317



200551

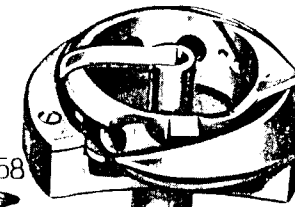

208498

203312

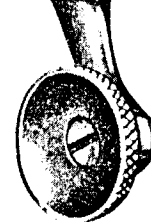
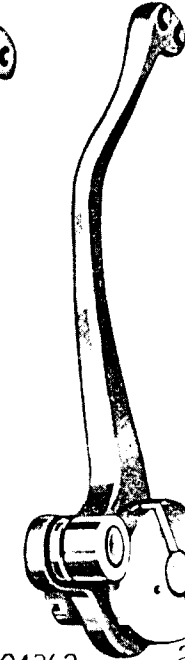
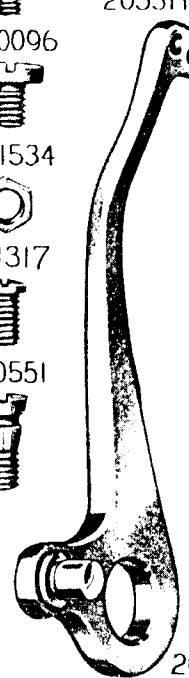

208497



204263

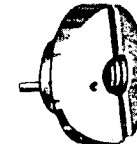

201910

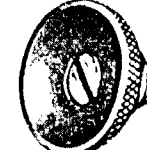

PLATE 12152—ONE-HALF SIZE

202781 227307 227303 227302 208490

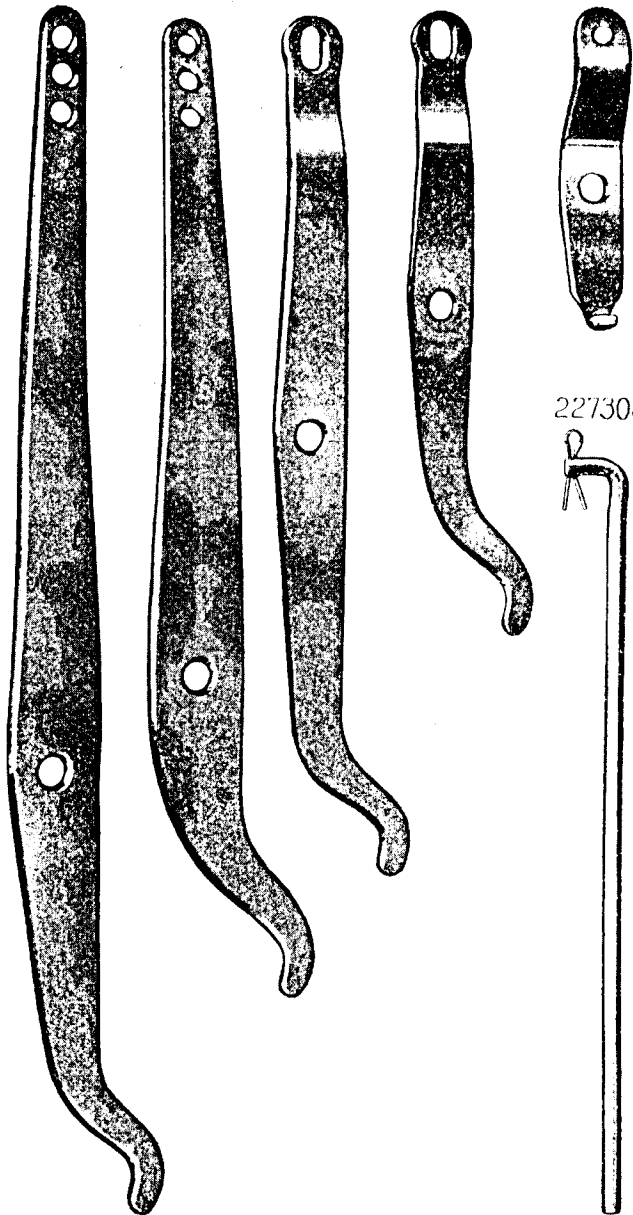
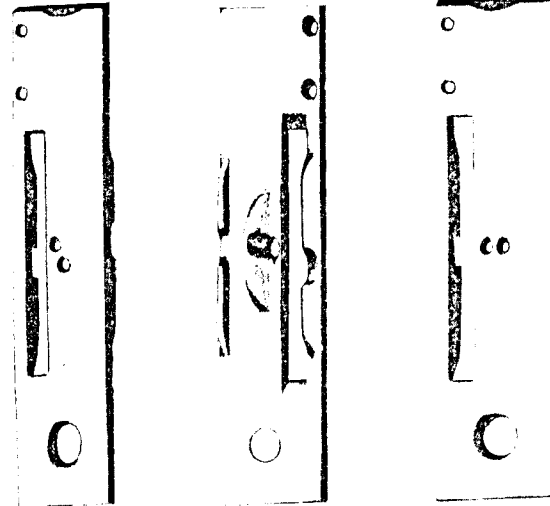

PLATE 12154—FULL SIZE

212176
212177
212178
212179

212176
212177
212178
212179

212182



212180
212200

212180
212200

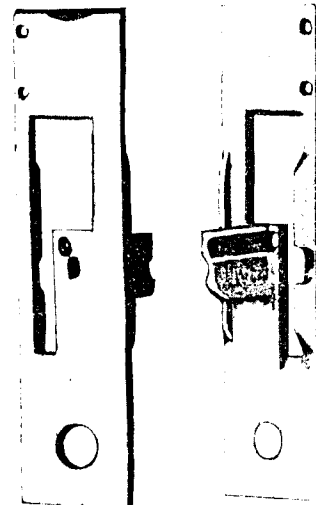

PLATE 12155-FULL SIZE

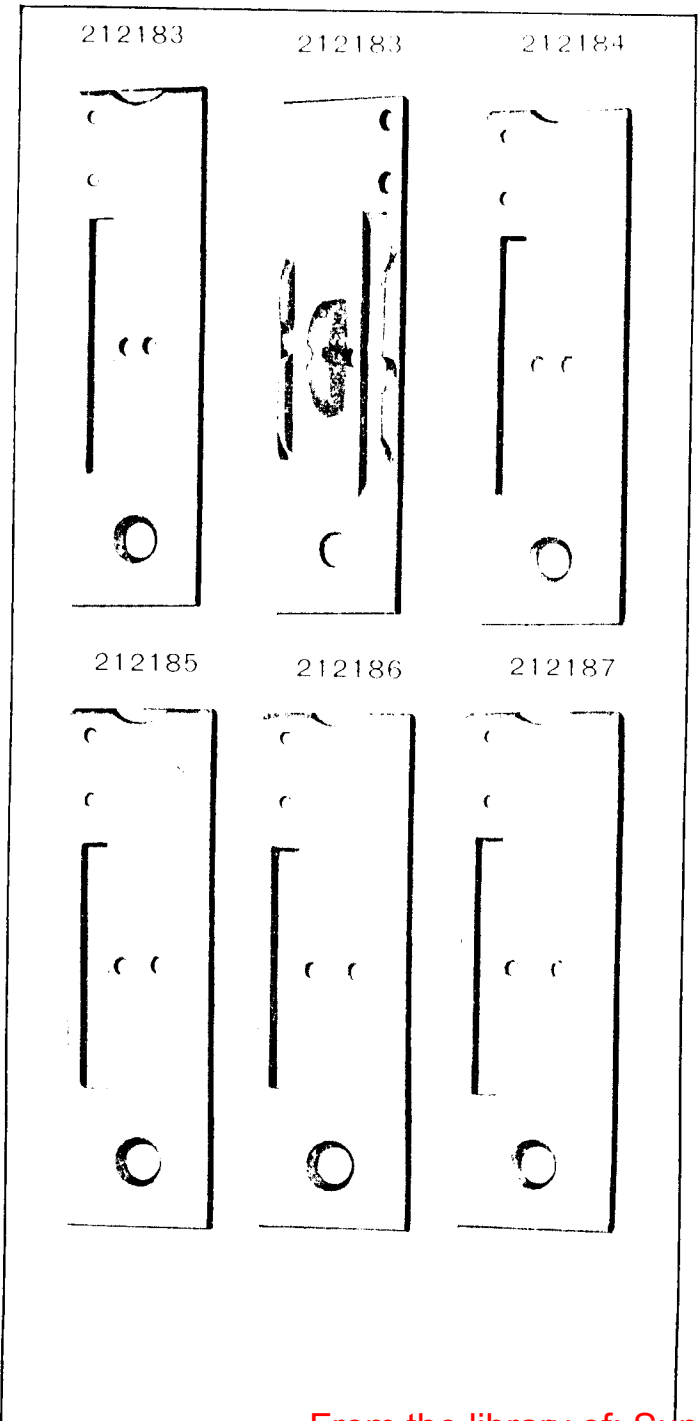

PLATE 12156-FULL SIZE

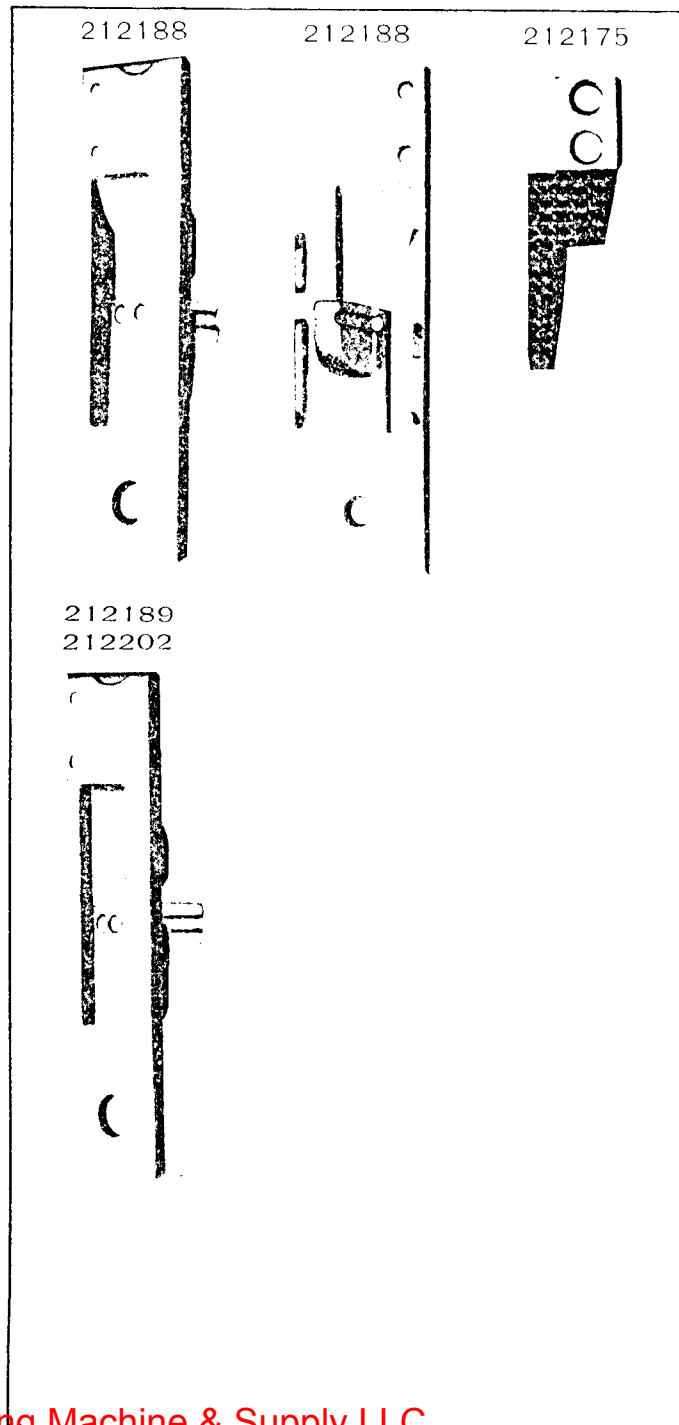

PLATE 12157—FULL SIZE

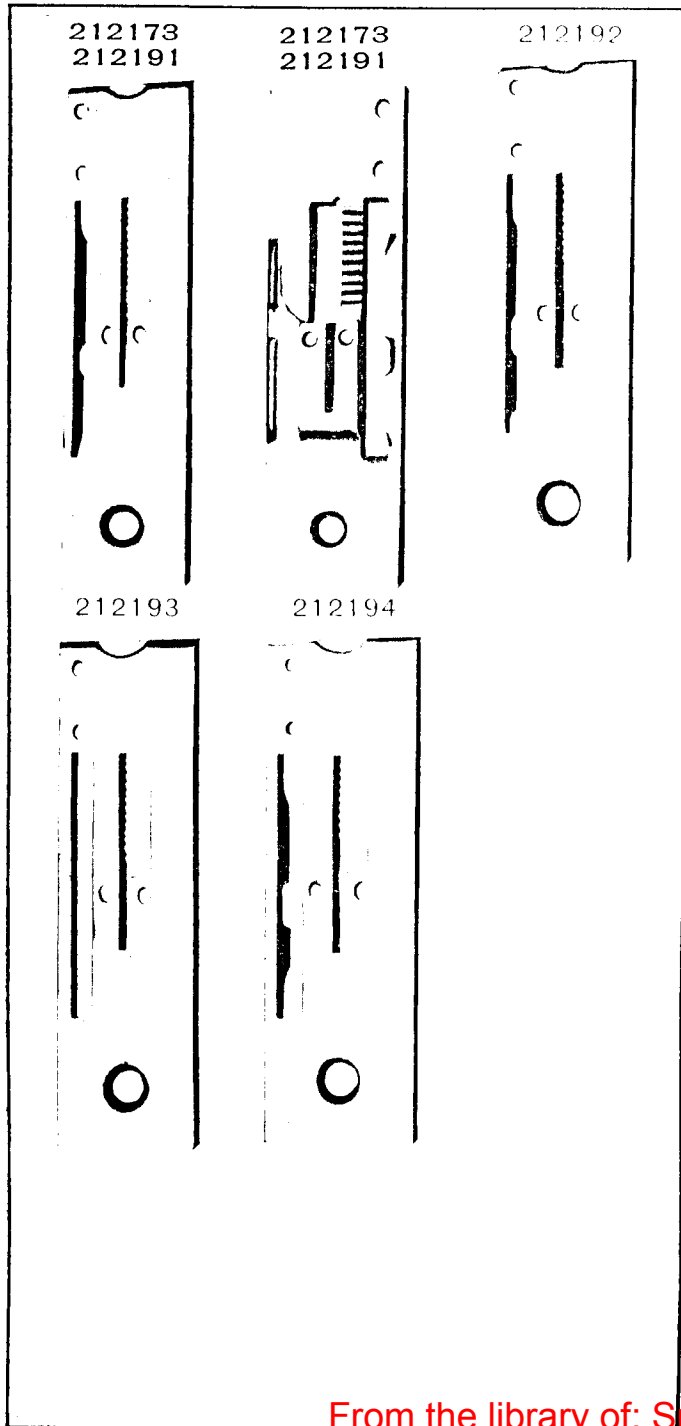

PLATE 12159—FULL SIZE

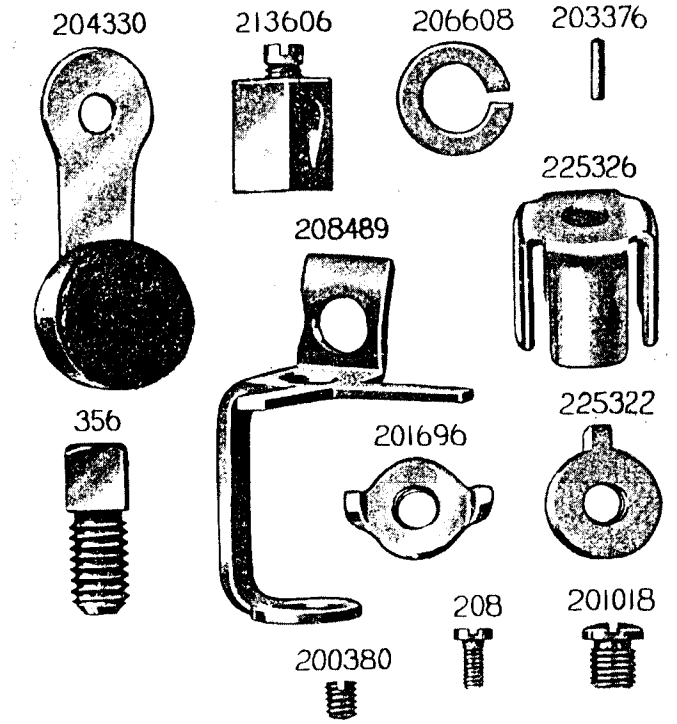

PLATE 12160—ONE-HALF SIZE

204495



229345



27739

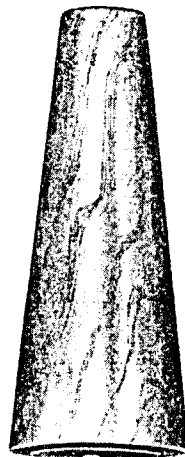

41400



PLATE 12167—FULL SIZE

212117



212129



212151



229744



212120



212132



212154



229745

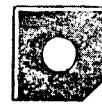

350061

202760



212123



211805



211652



229347



212126



212148



231398



200077



200064



PLATE 12305—FULL SIZE

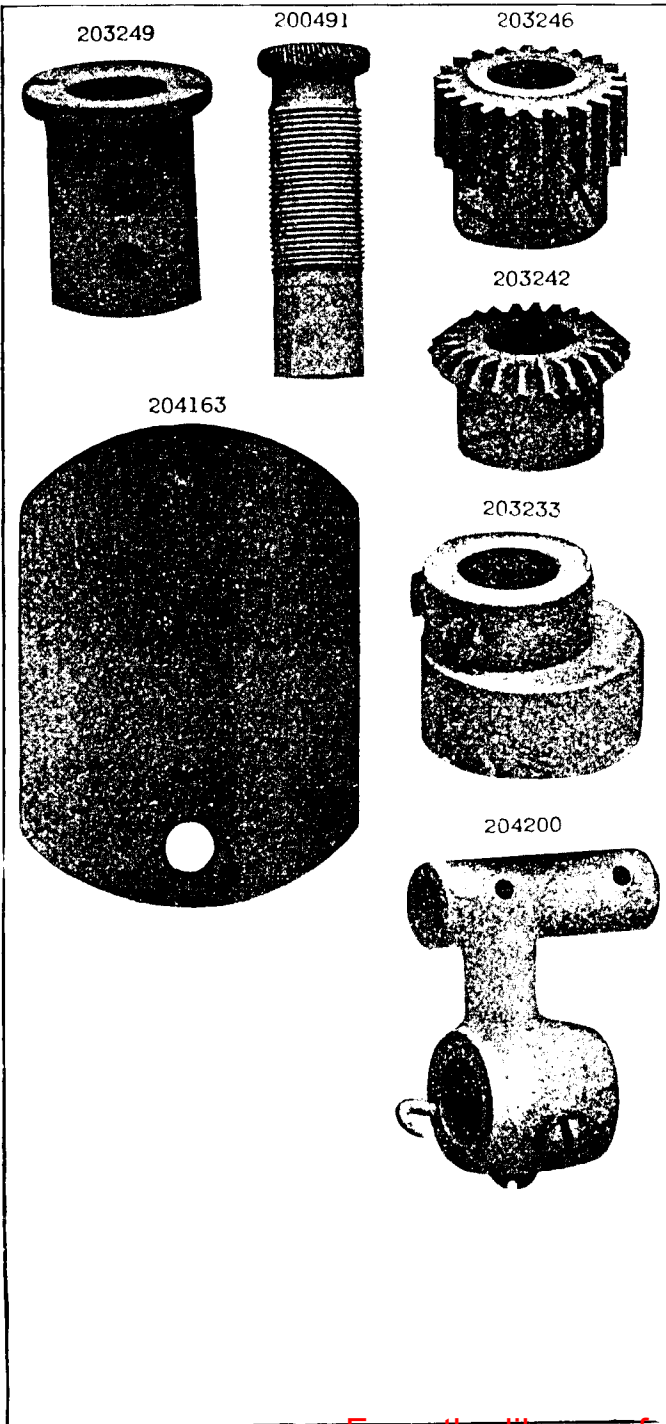

PLATE 12306—FULL SIZE

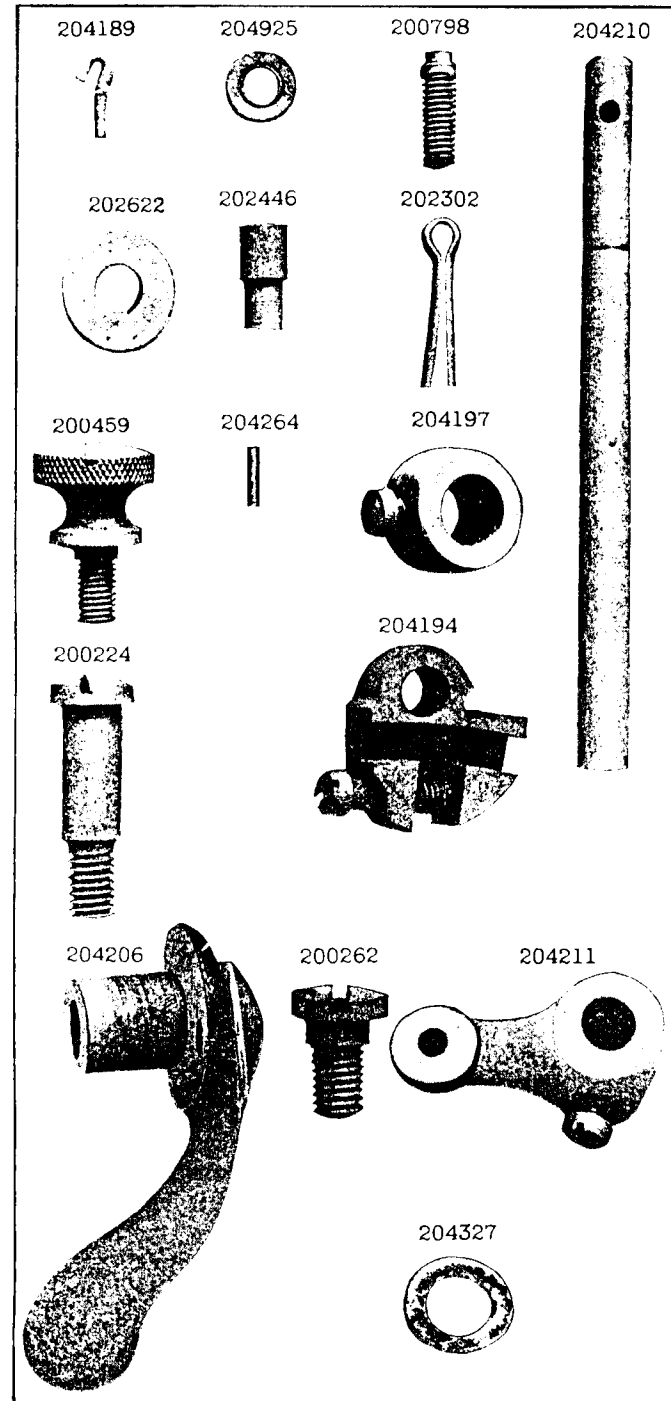

PLATE 12307—FULL SIZE

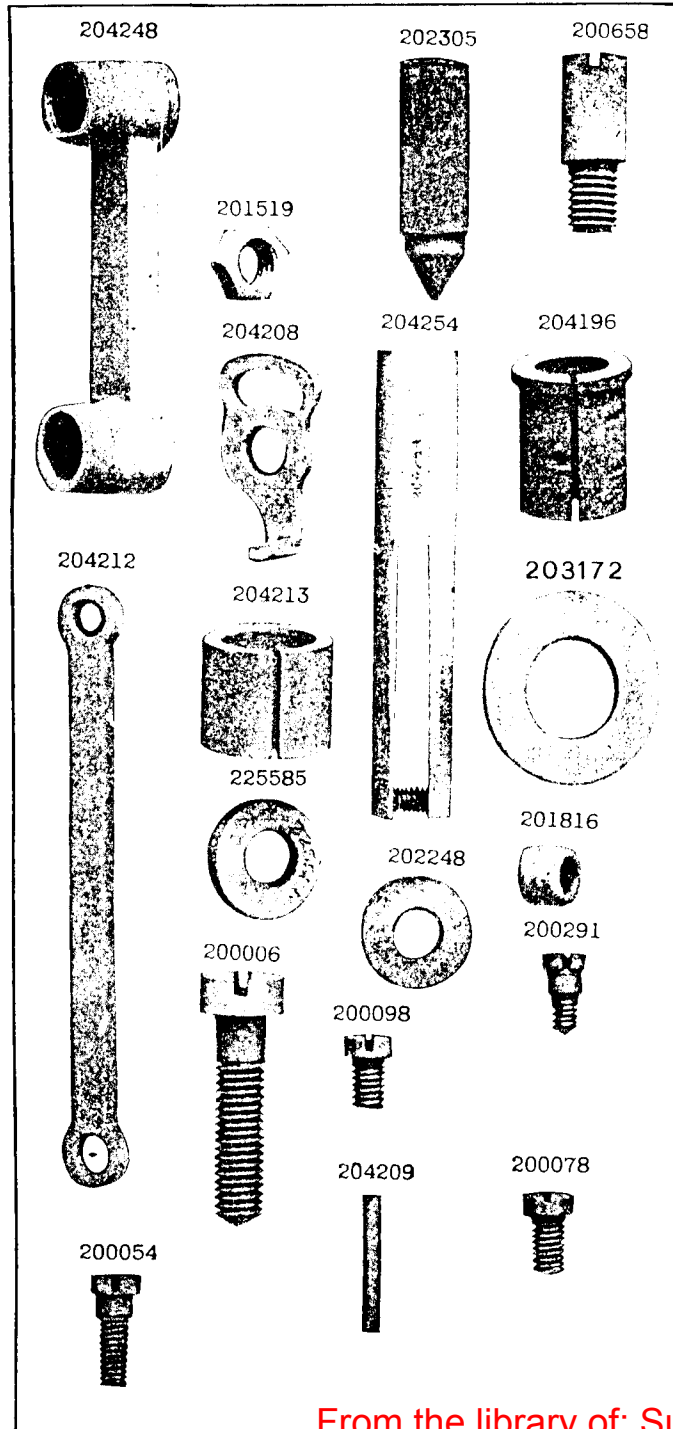

PLATE 12308—FULL SIZE

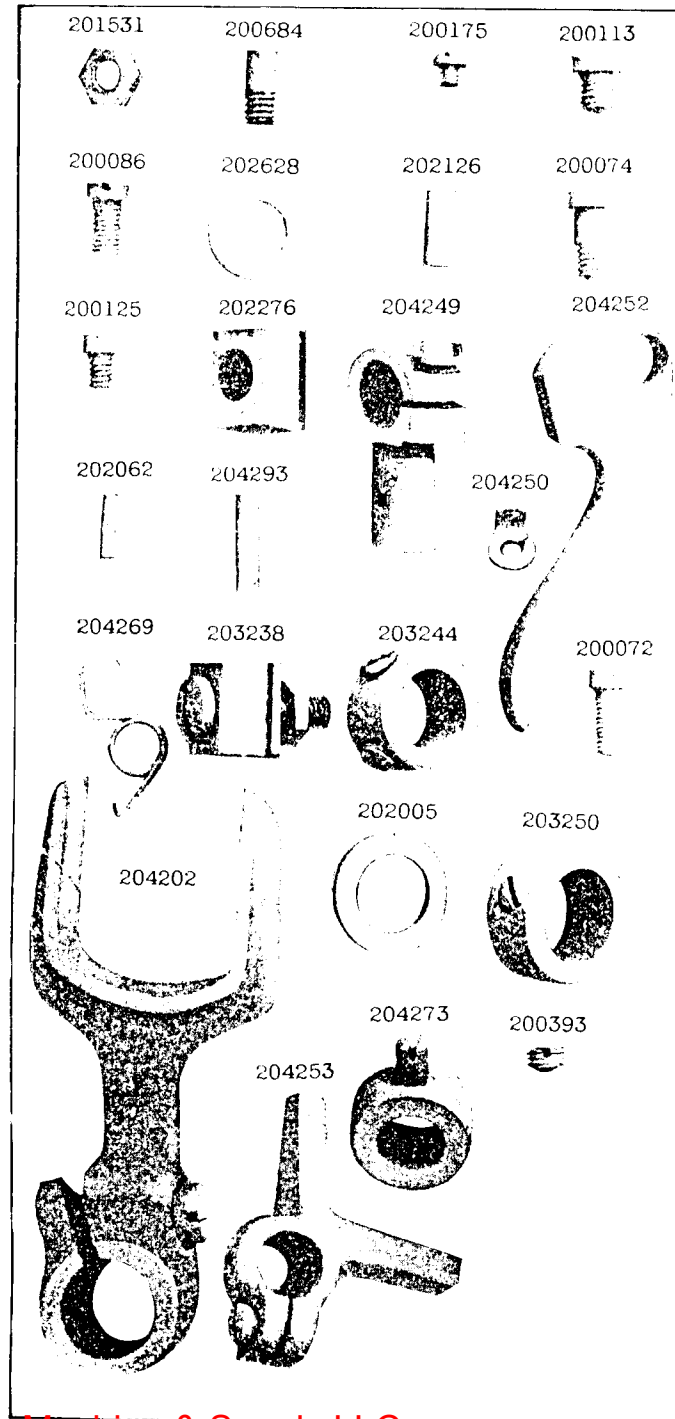

PLATE 12309 - FULL SIZE

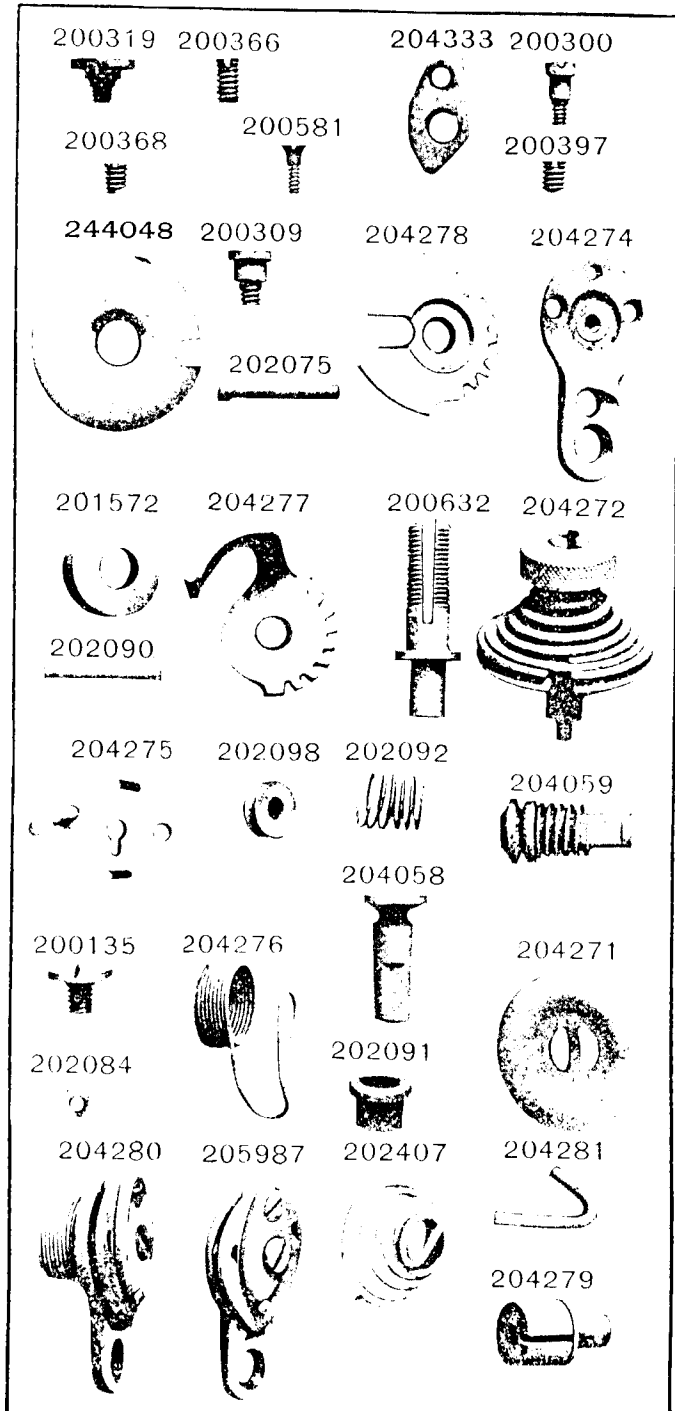

PLATE 12311 - FULL SIZE

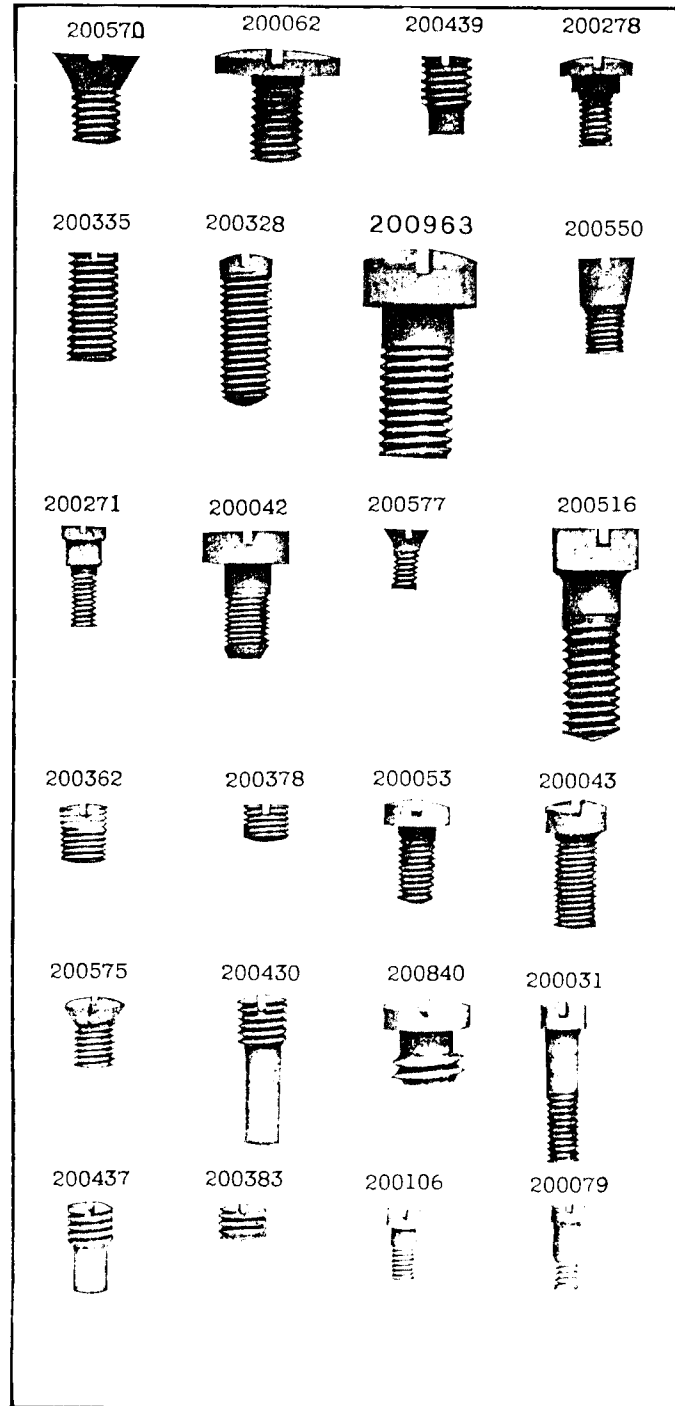

PLATE 12319 --FULL SIZE

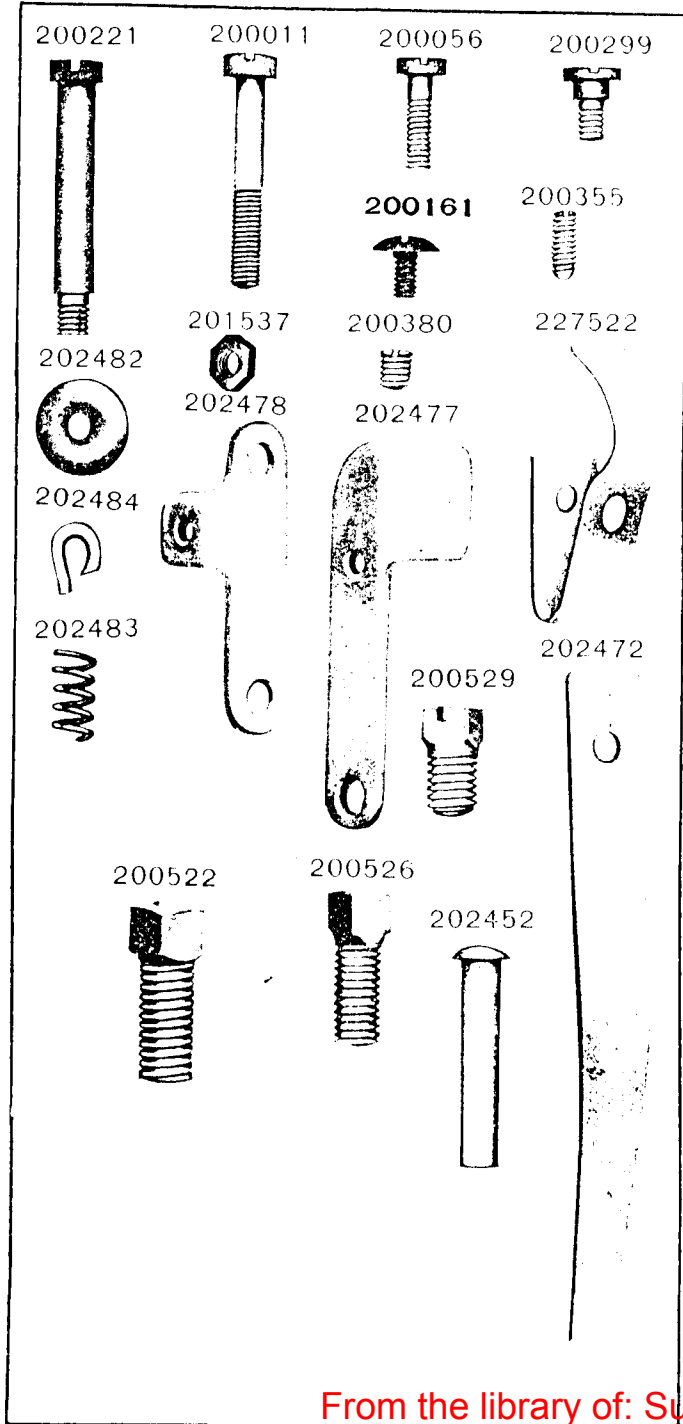

PLATE 12320--ONE-HALF SIZE

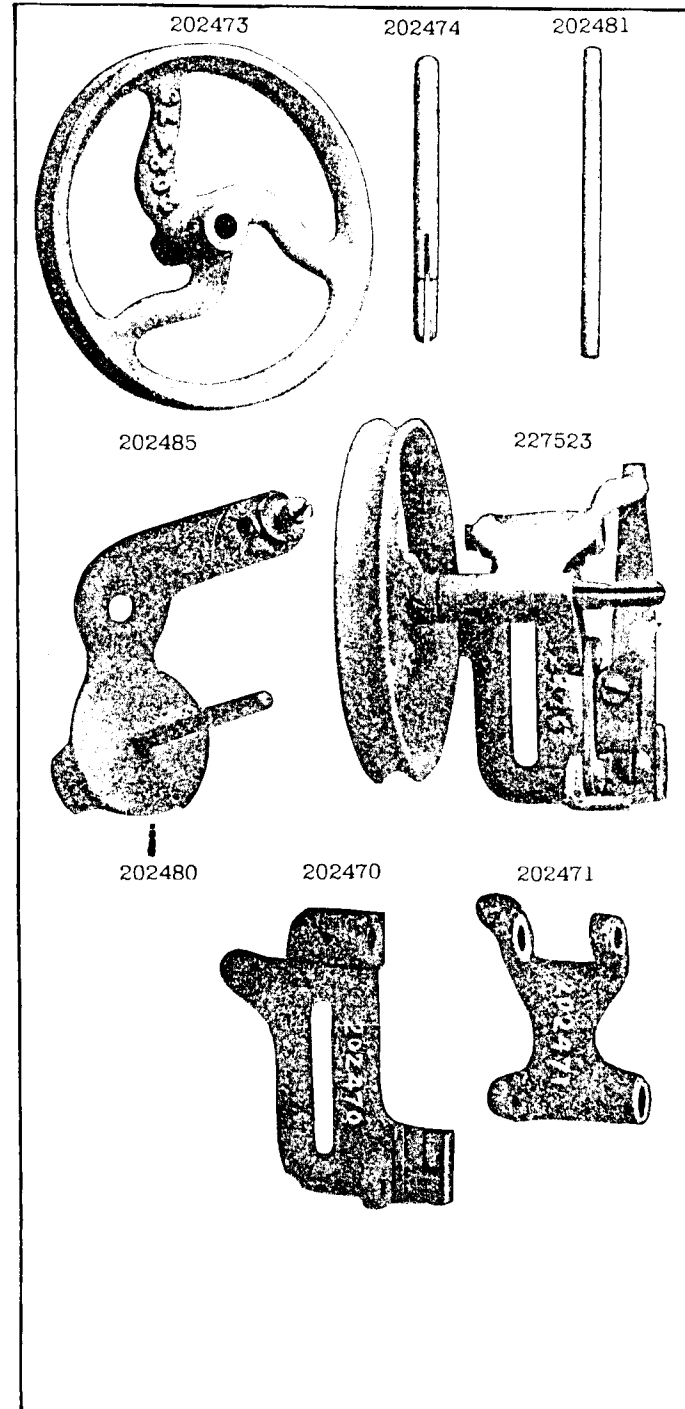

PLATE 12333—ONE-FOURTH SIZE

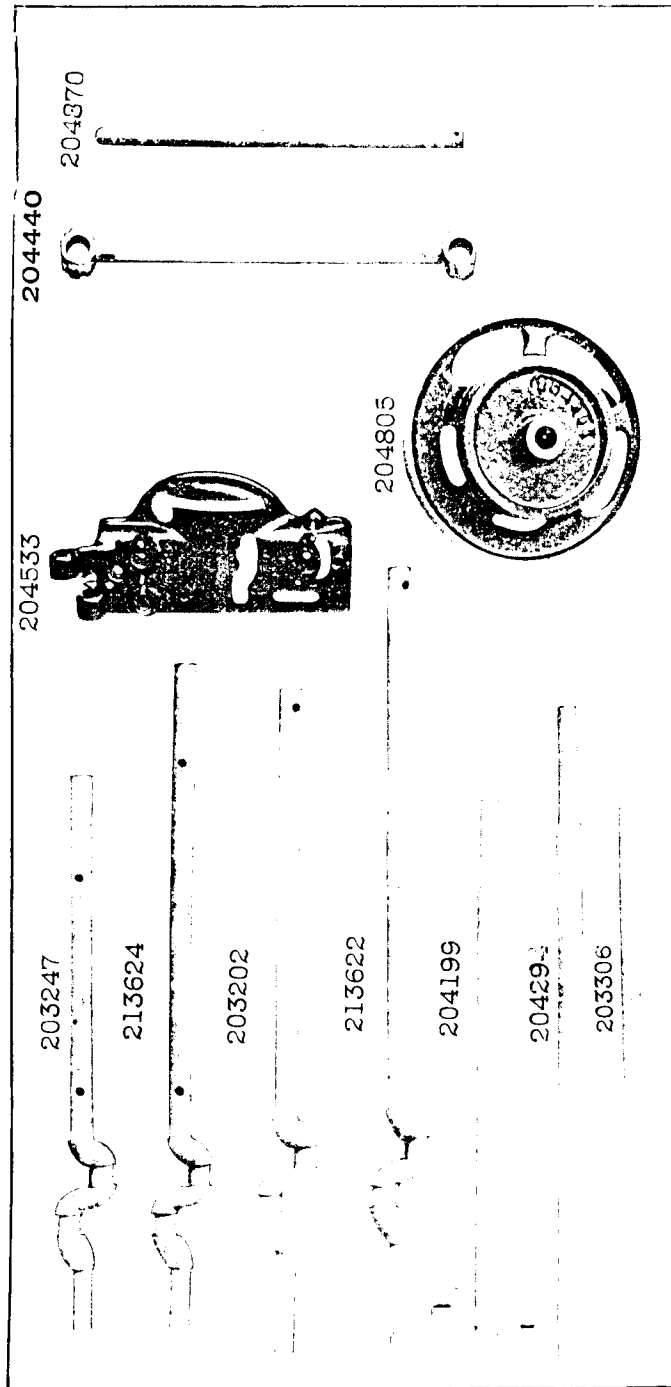

PLATE 12334—ONE-HALF SIZE

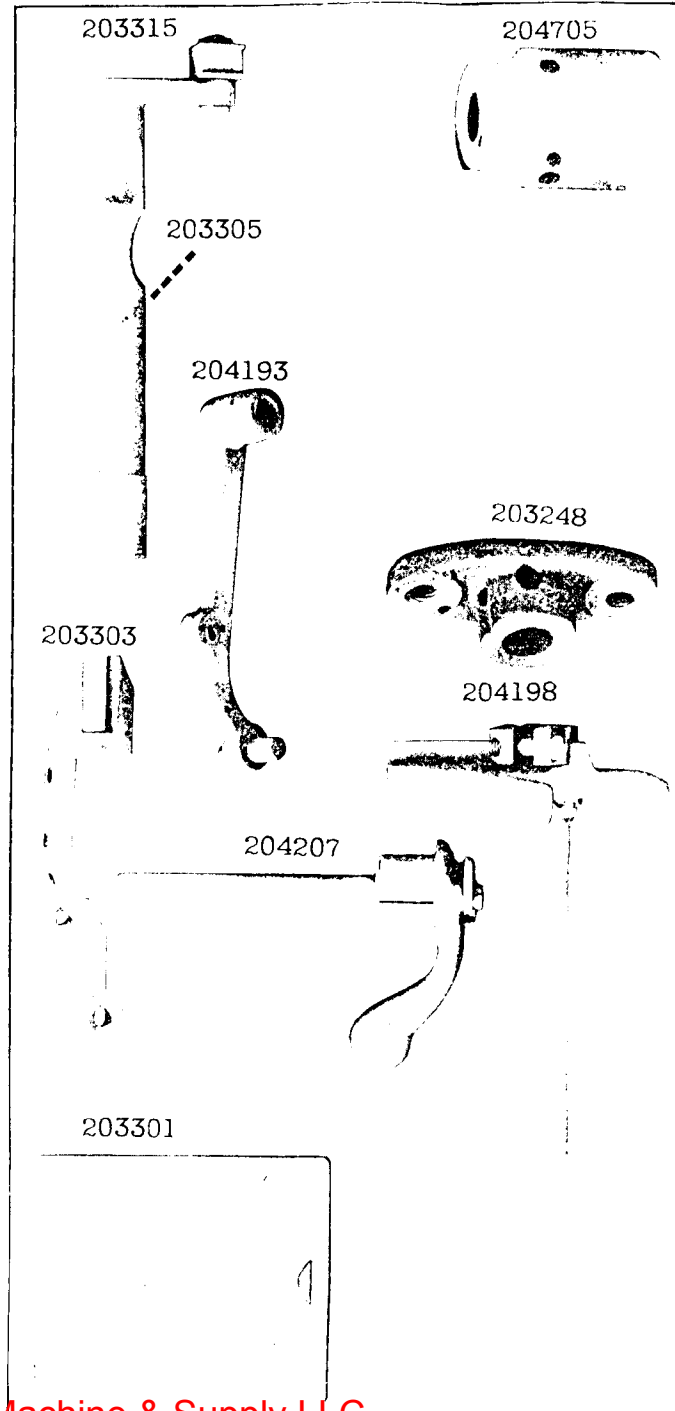

PLATE 12338—FULL SIZE

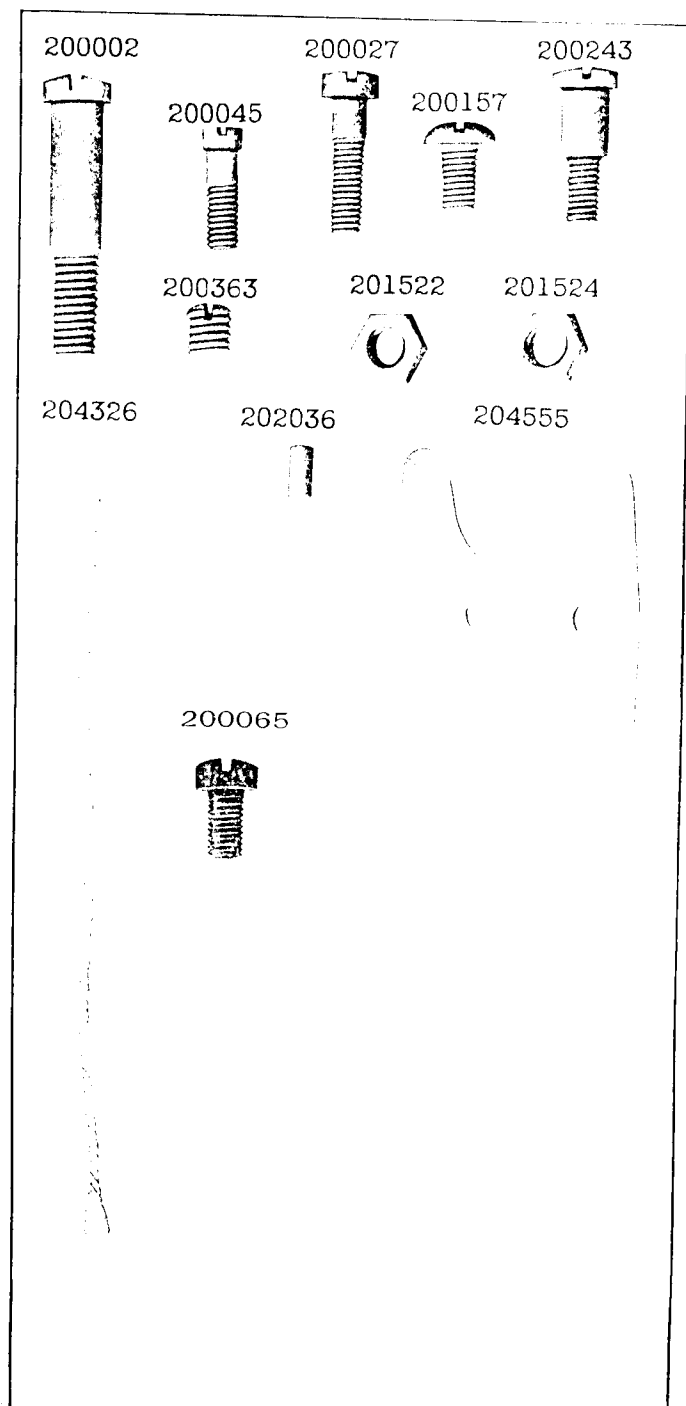

PLATE 12388—FULL SIZE

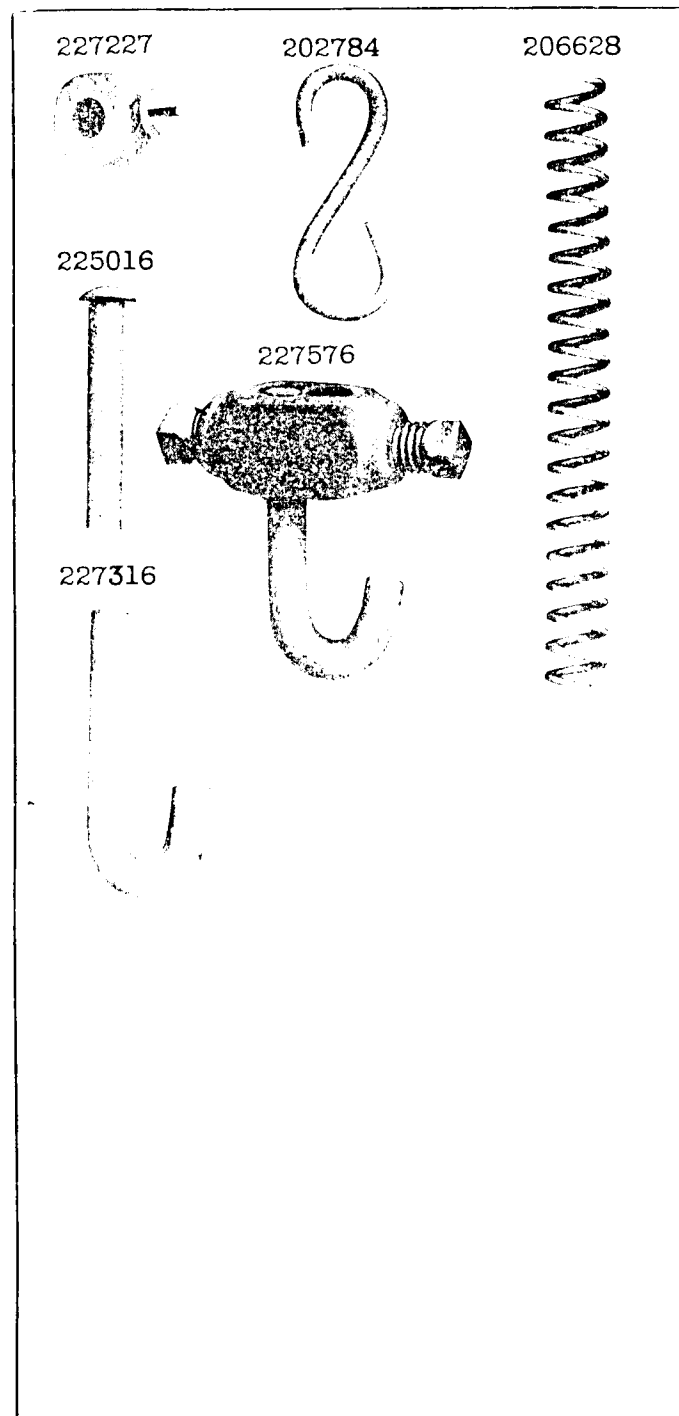
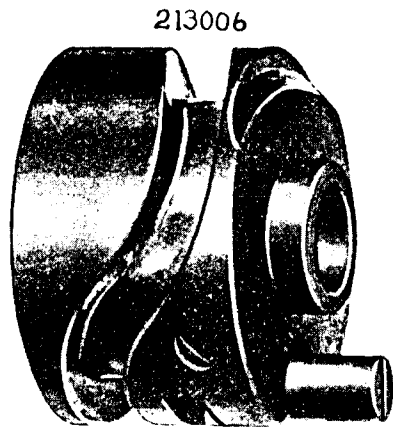

PLATE 13045-FULL SIZE



213006



213141



204258

200548



203214



204235



200382



201253



200984



200594



201376



PLATE 13105-FULL SIZE

204730 204556 214424 200075 203313



200214



200668



200530



200068



200094



201030



200134



200396



200504



200503



204243



204925



201535



201525



202258

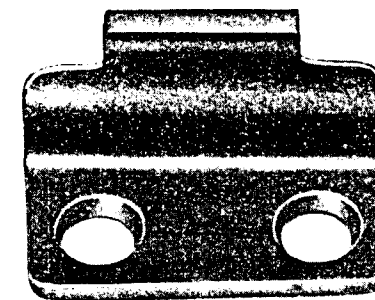
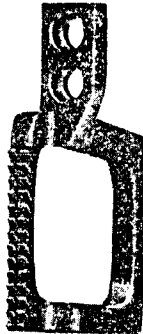

PLATE 13106—FULL SIZE

212100



212103



212104



211650



212179

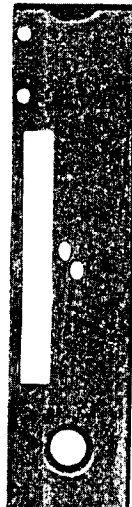

231381

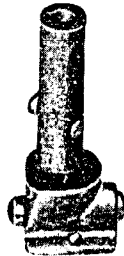

203701



201907

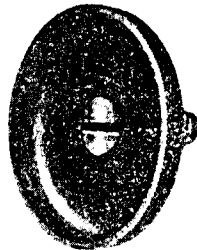

229339



229329



213699



PLATE 13395—ONE-FOURTH SIZE

228285

228282

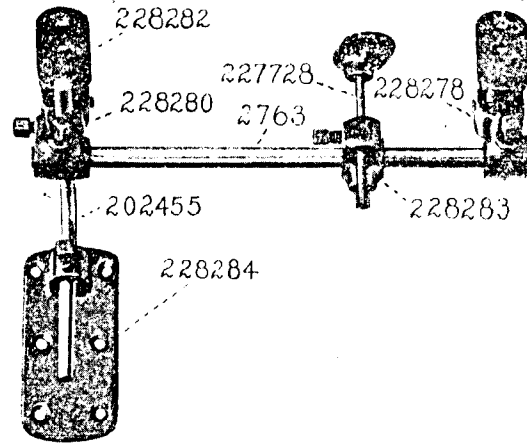

PLATE 14083—ONE-SIXTH SIZE

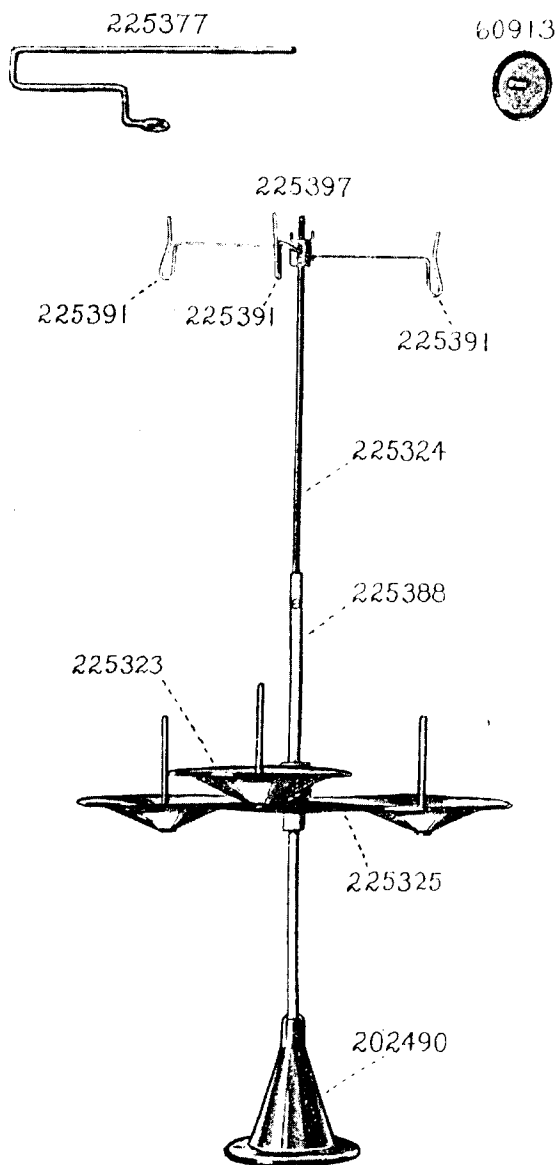

PLATE 14309—FULL SIZE

